

OPERATOR'S  
INSTRUCTION  
BOOK

CINCINNATI No. 2  
CUTTER and TOOL GRINDER



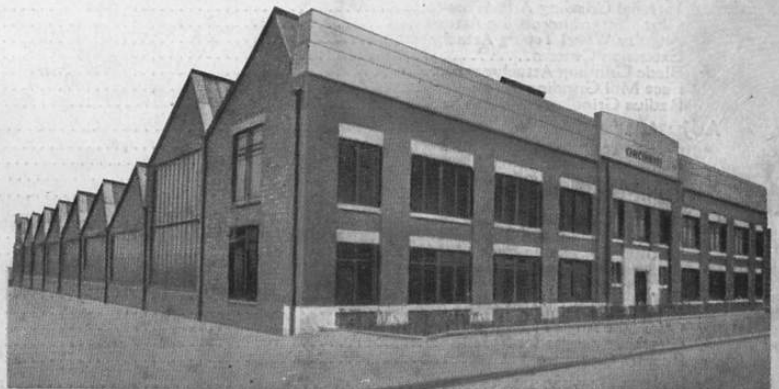
*Place this Booklet in the  
Hands of the Machine  
Operator or Set-Up Man*

CINCINNATI MILLING MACHINES, LTD.  
WOODLANDS FARM ROAD . . . TYBURN  
BIRMINGHAM, ENGLAND

*N. H. Earne*  
TOOL ROOM

**A**NY CUTTER can be sharpened and still produce as good a finish and as true a form as a new cutter. In fact, new cutters of the type which are sharpened by grinding the periphery of the teeth should not be used until they are ground to the proper clearance angle for the material to be machined.

This booklet gives, in a condensed form, tables and data which are necessary to set up and grind all the ordinary types of milling cutters on the No. 2 CINCINNATI Cutter Grinder. Of course, a wide variety of small tool room work can also be economically and accurately ground with the aid of the standard attachments. Detail instructions for the operation, lubrication and adjustment of the machine are given to help the new operator to understand more fully the operation and care of his machine.



CONTENTS

	Page
Machine Specifications .....	
Lubrication .....	4-5
Chart .....	4
Specifications .....	5
Operation of Machine .....	6-11
Operating Features .....	6
Starting .....	7
Table Feed .....	7
Cross Feed .....	7
Vertical Feed .....	7
Swiveling the Wheel Head .....	7
Setting Up the Tailstock or Work Head .....	7-8
Spindle and Wheel Speeds .....	8
Wet vs. Dry Grinding .....	8
Truing the Wheel .....	9
Grinding Wheels .....	9-10-11
Direction of Rotation of Wheel .....	11-12
Safety Precautions .....	12-13
Protective Hoods .....	12
Flanges, Washers and Nuts .....	12
Inspection and Storage of Wheels .....	12
Operating Rules and General Data .....	13
Clearance Angles for Milling Cutters .....	14-16
Grinding Cutters .....	16-36
Grinding a Spiral Mill .....	17-18
Grinding a Spiral End or Shell End Mill .....	19-21
Grinding a Small End Mill .....	21
Grinding a Keyway or Slotting Cutter .....	22
Grinding a Side Milling Cutter .....	22
Grinding a Stagger Tooth Cutter .....	22-23
Grinding an Angular Cutter .....	23
Grinding Small Diameter Face Mills .....	23
Grinding Small Diameter Metal Cutting Saws .....	23-24
Grinding Large Diameter Metal Cutting Saws .....	24-25
Grinding the End Teeth of Long End Mill .....	25
Grinding a Helical Cutter .....	26-27
Grinding a Tap .....	27-28
Grinding a Hob .....	28-29
Grinding a Reamer .....	29-36
Hand Reamers .....	30-33
Grinding a Hand Reamer for Steel .....	31-32
Grinding a Hand Reamer for Cast Iron and Bronze .....	32
Chucking or Machine Reamers .....	33-35
Grinding a Chucking Reamer for Steel .....	33-34
Grinding a Chucking Reamer for Cast Iron .....	35
Grinding a Chucking Reamer for Bronze .....	35
Taper Reamers .....	35-36
Attachments .....	37-50
Surface Grinding Attachment .....	37
Cylindrical Grinding Attachment .....	38
Internal Grinding Attachment .....	39
Gear Cutter Sharpening Attachment .....	40-43
Angular Wheel Truing Attachment .....	44-45
Extension Centres .....	45
Blade Grinding Attachment .....	45-46
Face Mill Grinding Attachment .....	46-49
Radius Grinding Attachment .....	49-50
Adjustments for Wear .....	50-52
Adjusting the Headstock (Work Head) Spindle Bearings .....	50
Replacing the Grinding Wheel Spindle Bearings .....	51
Replacing the Main Driving Belt .....	51
Tightening the Belt .....	52
Grinding Cemented Carbide Blade Milling Cutters .....	52-62
Method when using Regular Headstock for Grinding 8" Diameter Face Mill .....	53-57
Method when using Face Mill Grinding Attachment .....	57-62
Tables .....	9
Grinding Wheels .....	15
Clearance Angles for Milling Cutters .....	27
Clearance Angles for Helical Cutters .....	62
Clearance Angles for Face Mills .....	63-64
Reamer Clearance Tables .....	63-64
Ordering Repair Parts .....	Inside Back Cover
List of Agents .....	Cover



LUBRICATION

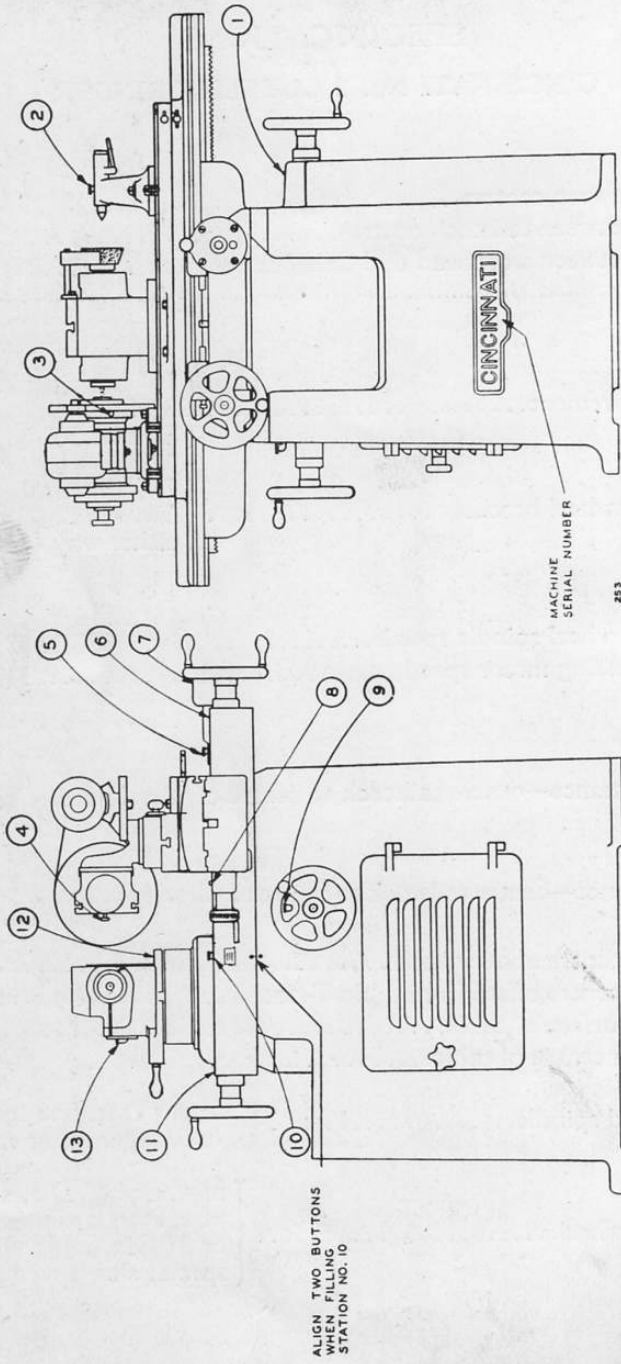


Fig. 1  
Lubrication Chart for No. 2 Cincinnati Cutter Grinder

LUBRICATION

TOOL ROOM

LUBRICATING INSTRUCTIONS AND SPECIFICATIONS

When to Oil	Station Number	Parts Lubricated	Instructions	Specifications
Once a Day	1	Elevating Shaft Brg.	Oil from squirt can	Medium machine mineral oil Viscosity 190 to 210 seconds Saybolt at 100° F.
	2	Tailstock	Oil from squirt can	
	3	Work Head Dial	Remove screw and oil from squirt can	
	4	Work Head Spindle	Oil from squirt can	
	5	Differential Shaft Bearings	Oil from squirt can	
	6	Front Cross Screw Brg.	Oil from squirt can	
	7	Differential Gear Bearings	Remove screw and oil from squirt can	
	8	Shaft Bearing	Oil with squirt can	
	9	Elevating Shaft and Worm	Oil from squirt can	
	10	Cross Screw	Oil from squirt can. Align two buttons when oiling.	
	11	Rear Cross Screw Bearing	Oil from squirt can	
	12	Column Bearing in Sleeve	Remove screw and oil from squirt can	
Refill When Necessary	13 (2 cups)	Wheel Head Spindle	Fill oil cups, when spindle is at rest, to top of glass (high oil level). Drain and re-fill every three months. About 1/8 pint required each filling.	High grade spindle oil Viscosity 120 to 130 seconds Saybolt at 100° F.
		Spindle	Adjust to use about one cup of oil each day.	
<b>DRIVING MOTOR IN BASE</b>				
Once a Day		Motor Bearings (two cups)	Keep grease cup filled—one turn daily	Good grade of cup grease without fillers. Min. flow temperature 270° F.

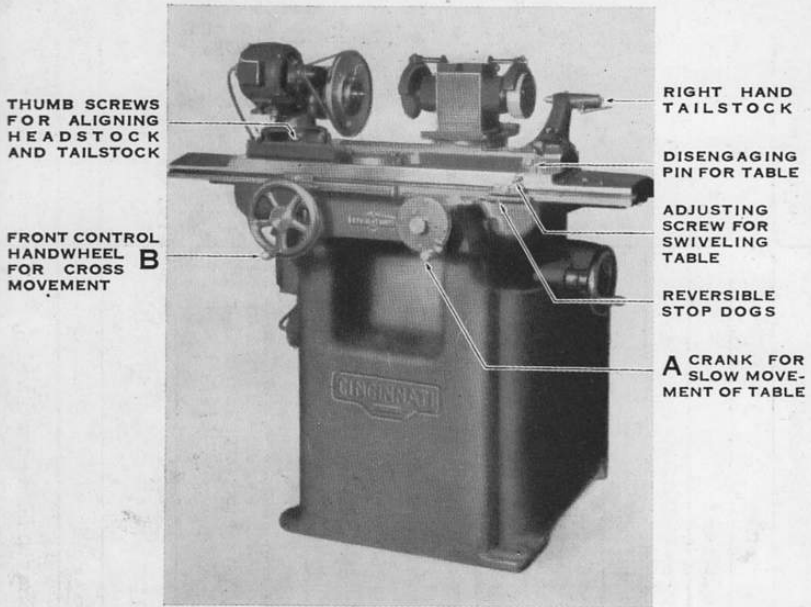


Fig. 2  
Front View No. 2 Cutter Grinder

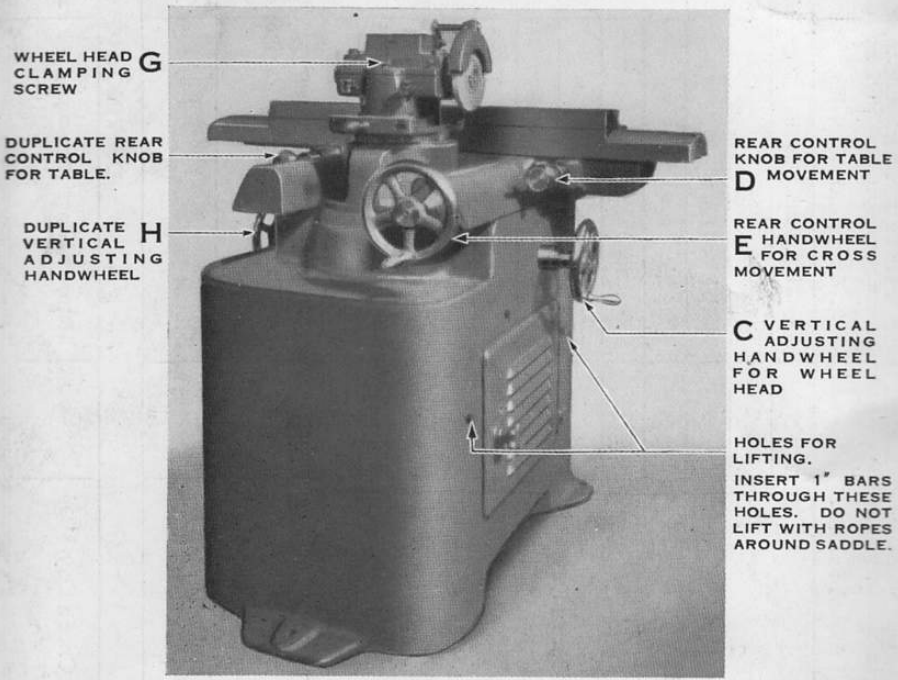


Fig. 3  
Rear View No. 2 Cutter Grinder

## OPERATING INSTRUCTIONS

**Starting the Machine.** Before starting the machine for the day's work, fill all the oil holes and cups shown on the lubrication chart, Fig. 1. When oiling the cross screw nut (Station 10) be sure to line up the two buttons, as specified on the instruction plate.

All Cincinnati No. 2 Cutter Grinders are individual motor drive, with the starting switch for the wheel head located on the rear of the base, and the starting switch for the work head motor located on the left hand side of the bed.

**Table Feed.** Crank "A" (Fig. 2), through a 10 to 1 differential gearing, moves the table from left to right when turned in a clockwise direction. One turn of the crank moves the table  $\frac{3}{8}$ ". Rear control knob "D" (Fig. 3) is connected directly to the pinion which engages the table rack, and cannot be used until the differential crank "A" is disengaged. To disengage this crank, pull out the knob in the centre of the crank housing.

**Cross Feed.** Hand wheel "B" moves the table and saddle away from the grinding wheel when turned in a clockwise direction. One turn of the handwheel moves the saddle  $\frac{1}{8}$ ". The micrometer dial is graduated into 125 spaces, which is equivalent to .001" movement of the saddle for each space.

Hand wheel "E" is for the rear control movement of the saddle, and moves the saddle and table towards the grinding wheel when turned in a clockwise direction. The amount of motion per turn and the dial markings are the same as for the hand wheel "B".

**Vertical Feed.** Hand wheel "C" moves the column and wheel head up when turned in a clockwise direction. One turn of the hand wheel moves the wheel head  $\frac{1}{10}$ ". The dial is graduated into 100 equal divisions, which is equivalent to .001" movement for each division.

Hand wheel "H", which is a duplicate vertical control, is very convenient when working at the right hand side of the machine. The dial markings and the amount of motion for one turn are the same as for hand wheel "C".

**Swiveling the Wheel Head.** Loosen screw "G", swivel the wheel head right or left as desired, then re-tighten the screw. The wheel head can be swiveled 120° in either direction.

**Setting Up the Tailstock or Work Head.** When setting up the tailstock or work head, tighten the thumb screws in front of the unit before tightening



the tee bolts for holding the unit to the table. This step is necessary because the tongues are a loose fit in the slot, and therefore the unit must be lined up by locating against one side of the slot before being clamped down.

**Spindle and Wheel Speeds.** The wheel head motor, running at 3425 r. p. m., drives the wheel spindle at 3850 or 5735 r. p. m. The drive is from a two step pulley on the motor shaft, through an endless belt, to a single step pulley on the wheel spindle. When using the 6" diameter grinding wheels, shift the belt to the small pulley, and when using the 3½" wheel, shift it to the large pulley. Shifting the belt from one pulley to another is accomplished as follows:

1. Stop the motor.
2. Open the door in the side of the bed.
3. Loosen the two hex head screws which hold the motor plate to the column.
4. Raise or lower the motor as required and shift the belt.
5. Tighten the screws.

The same procedure is followed for tightening the belt.

The surface speed of the grinding wheel should be between 5000 and 6000 feet per minute to obtain the longest life and best cutting action of the wheel. If the wheel head motor is changed to one with a different speed, the pulley diameters must be increased or decreased to keep the proper wheel speed. Surface speeds are figured from the following formulae:

$$\text{r. p. m. spindle} = \frac{\text{r. p. m. of motor} \times \text{dia. pulley on motor}}{\text{dia. pulley on wheel head}}$$

$$\text{surface speed (ft/min.)} = \text{r. p. m. spindle} \times \frac{3.14 \times \text{diam. wheel}}{12}$$

**Wet vs. Dry Grinding.** If a piece of glass is heated on the edge, and then suddenly plunged into cold water, the glass will crack. A similar principle is applied when wet grinding cutters. The heat developed by a cutter grinder wheel is concentrated in a very small area. If water is applied, the heat is taken away so rapidly that small cracks appear at the extreme cutting edge of the teeth. On the other hand, if the cutter is ground dry, the heat has a chance to flow from the high heat area between the cutter and the wheel to the body of the blade. The cutting edge is thereby heated

OPERATING INSTRUCTIONS

TOOL ROOM

gradually, and no cracking occurs. Aside from this point, there is the further advantage that the cutting action can be observed more closely if the cutter is ground dry.

**Truing the Wheel.** The grinding wheel must be trued occasionally to obtain a good finish on the clearance angles of the cutter, for a good finish makes a keen cutting edge. A piece of carborundum stick or part of a broken grinding wheel may be used for ordinary truing of the dish and cup wheels. For accurate truing, as required for cylindrical and surface grinding, the wheel truing attachment shown in Fig. 4 should be used. When truing the wheel with the attachment use the front hand control to give the table a uniform motion, because the diamond will produce a much better surface on the wheel if it is moved uniformly.

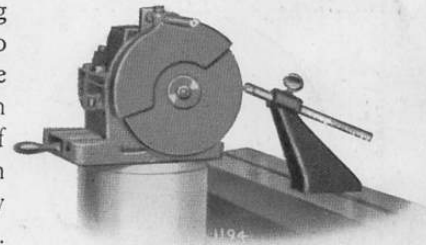


Fig. 4  
Wheel Truing Attachment

TABLE OF GRINDING WHEELS AND THEIR USES (See Fig. 5)

Shape Number	Material	Uses
Nos. 26 or 29	60. M. BLU Aloxite	Internal Grinding
No. 28	E. 60. K6X Aloxite Redmanol	Spiral Mills, Reamers, End Mills, Angle Mills, Stagger Tooth Slotting Cutters
No. 21	50. P. 25 Aloxite	Gear Cutters, Formed Cutters, Hobs, Taps, Boring Cutters
No. 23	50. P. 25 Aloxite	Reamers, Spiral Mills, Slotting Cutters, Face Mills, Angle Mills, End Mills
No. 24	50. P. 25 Aloxite	Flat Forming Tools, Lathe and Planer Tools, Screw Machine Tools, Work Rest Blades, Straight Edges, Gauges, Drifts
No. 25	100. ME. 3 Carborundum	Cylinder Grinding, Surface Grinding
No. 27	4. 46. T. 600 Aloxite	Face Mills
No. 30	70K-4T Aloxite	Cutting off Stellite, High Speed Steel, etc.

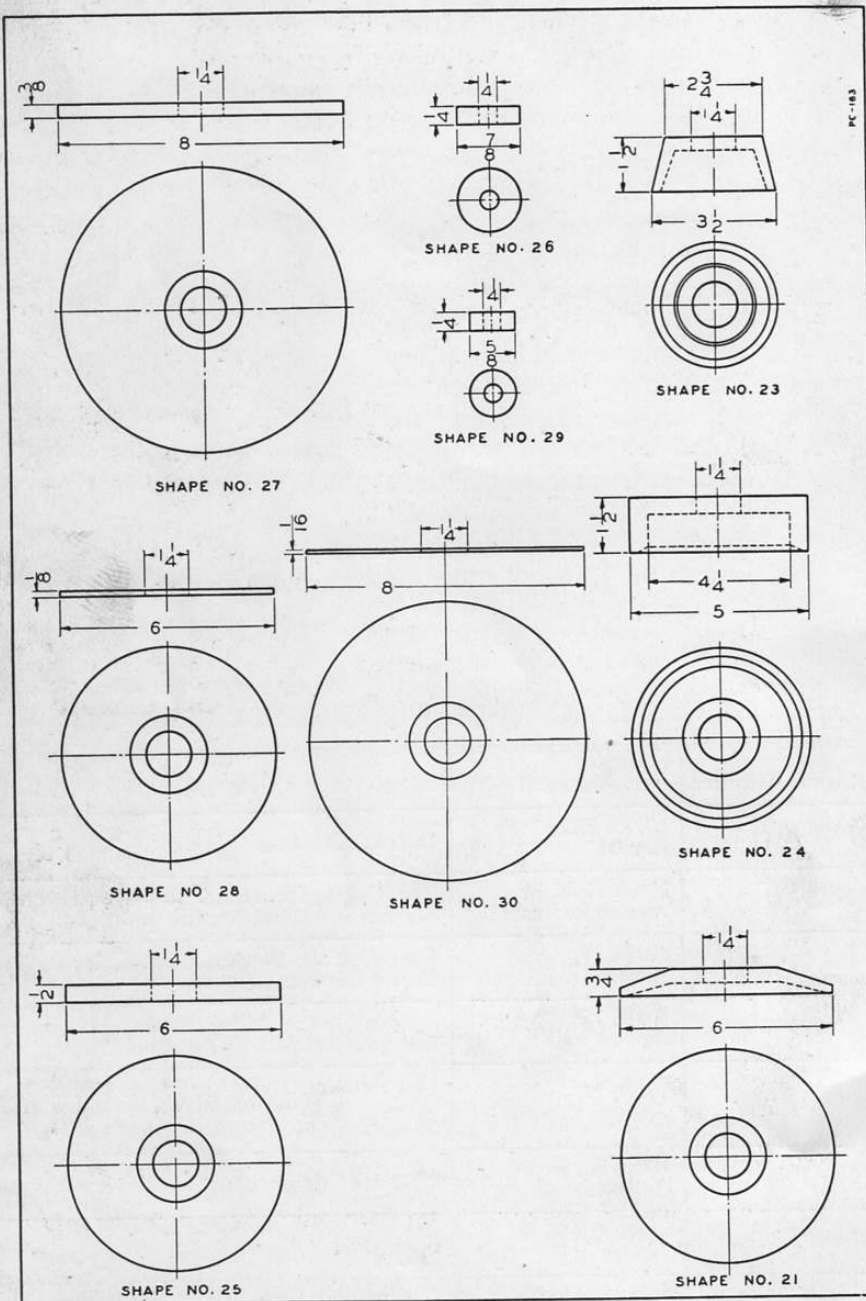


Fig. 5  
Grinding Wheels Used on Cincinnati No. 2 Cutter Grinder

**Grinding Wheels.** When grinding a high speed steel cutter or reamer, use a soft wheel. The soft wheel breaks down more easily and is therefore less liable to burn the cutter. Since a soft wheel wears away quickly, it is desirable to dress it often to obtain a good surface on the wheel and therefore a good finish on the work. A carbon steel cutter can be ground with a harder wheel of fine grain, without drawing the temper. Some jobs, particularly surface grinding, require wheels not listed in the table. We can supply them, when necessary, at extra cost.

**Direction of Rotation of Wheel.** The standard direction of rotation of the grinding wheel is towards the cutting edge of the tooth, as shown in Fig. 6. We believe that this direction of rotation produces the best results. Many years of experience in building cutter grinders and sharpening cutters are the basis for this statement; consequently, Cincinnati Cutter Grinding Machines are built with this principle in view. The chief advantage is important—there are no burrs left on the cutting edges of the teeth to be removed by a painstaking oil-stone operation.

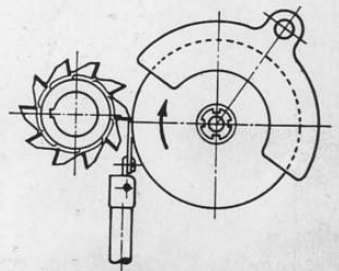


Fig. 6  
Grinding Wheel Rotating Towards the Cutting Edge.  
(This is the Standard Wheel Rotation for CINCINNATI Cutter Grinders)

However, if you believe that the wheel should rotate in the opposite direction, as shown in Fig. 7, the machine can easily be adapted to this method of grinding by turning the spindle end-for-end, as explained in the following paragraphs:

1. Open the door on the side of the bed and remove the belt from the motor pulley.
2. Loosen clamp screws "B" and tighten spreader screws "C" (Fig. 75, page 51).
3. Remove screws "A".
4. Remove the spindle assembly, turn it end for end and then replace it. Of course, the belt must be in position.
5. Replace screws "A", being certain that the point of the screw fits easily into the drilled hole in the spindle retainer. Otherwise you may spring the spindle.

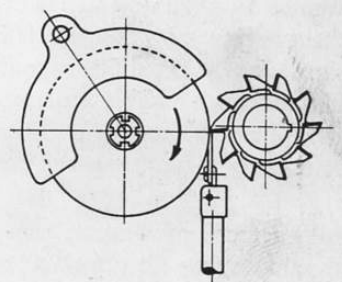


Fig. 7  
Grinding Wheel Rotating Away From the Cutting Edge

6. Release spreader screws "C" and tighten screws "B".
7. Replace the belt on the motor pulley.
8. Reverse the direction of rotation of the motor.

In making this change of spindle rotation, the Internal Grinding Attachment supplied with a universal machine becomes ineffective. However, a new internal spindle may be purchased which will be suitable for the new direction of rotation.



## SAFETY PRECAUTIONS

**Protective Hoods.** Protection hoods shall always be used with wheels which are not provided with protection flanges, chucks, or bands.

**Flanges, Washers, and Nuts.** All abrasive wheels shall be mounted between flanges, except those which are mounted in chucks.

Washers or flange facings of compressible material shall be fitted between the wheel and its flanges. If blotting paper is used, it should not be thicker than .025". If rubber or leather is used, it should not be thicker than  $\frac{1}{8}$ ". If flanges with babbitt or lead facings are used, the thickness of the facing should not exceed  $\frac{1}{8}$ ". The diameter of the washer shall be the same size or slightly larger than the flange diameter.

All surfaces of wheels, washers, and flanges in contact with each other should be free from foreign material.

**Inspection and Storage of Wheels.** Competent men shall be assigned to the mounting, care, and inspection of grinding wheels.

Immediately upon receipt, all wheels should be closely inspected to be sure that they have not been injured in transit. Inspect for cracks by tapping gently (whilst suspended) with a light implement, such as the handle of a screw driver. Wheels must be dry and free from sawdust when applying this test. If they sound cracked they must not be used. Note that organic

---

## SAFETY PRECAUTIONS

---

bonded wheels do not emit the same clear metallic ring as do vitrified and silicate wheels.

Extreme care should be exercised in the storage of wheels. They should be stored in a dry place and should be supported by pegs in racks.

**Operating Rules and General Data.** Run all new wheels at full operating speed for at least one minute before applying the work, during which time the operator should stand at one side.

Work should not be forced against a cold wheel, but applied gradually, giving the wheel an opportunity to warm and thereby minimize the chance of breakage. This applies to starting work in the morning in cold rooms, and to new wheels which have been stored in a cold place.

Grinding on the flat sides of straight wheels is often hazardous and should not be allowed on such operations when the sides of the wheel are appreciably worn, or when any considerable or sudden pressure is brought to bear against the sides.

When tightening the spindle end nut, care should be taken to tighten it just enough to hold the wheel firmly; otherwise the clamping strain is liable to damage the wheel or associated parts.

Do not use wheels of a larger diameter or a greater thickness than specified for this machine.

The space about the machine should be kept light, dry and as free as possible from obstructions.

All machines should be attached to a dust exhausting system.

Goggles should be provided for the use of operators to eliminate danger of eye injury.

A wheel guard should be used for every grinding operation. Guards are provided for all types of wheels included with the machine.

## CLEARANCE ANGLES

### For Milling Cutters

Milling cutters fall into two distinct classes, each class being sharpened by a method peculiar to itself.

Into the first class fall the cutters which are sharpened on the periphery or outside diameter by grinding a cutting and clearance angle behind the cutting edge. The great majority of milling cutters are of this type, of which an ordinary spiral mill is an example. Of course, this type of cutter is the least expensive, and it has the added advantage that it can be renewed and used over again when the teeth are ground down too small.

The second class includes all cutters which are form relieved and which must be sharpened by grinding the front faces of their teeth. These cutters have a definite profile for producing a given outline, the cutter profile being preserved when sharpening by grinding the front faces of the teeth only. The clearance is produced during the manufacture of the cutter. Gear cutters, form milling cutters, etc. are included in this type.

When setting up for grinding *radial* tooth form relieved cutters, bring the centre of the cutter in line with the face of the grinding wheel. For *under-cut* form relieved cutters, proceed as before, swivel the table or cutter through an angle equal to its rake angle and then align the face of one cutter tooth with the face of the wheel. If the rake is marked on the cutter in thousandths of an inch, (Dimension "D" in Fig. 60), offset the centre of the cutter from the face of the wheel by this amount. Set the face of a cutter tooth against the face of the grinding wheel, and set the tooth rest against the heel of the tooth. To adjust the work to the wheel, revolve the cutter towards the wheel a slight amount by adjusting the micrometer tooth rest. The faces of the teeth will then be ground to maintain the correct cutter profile. (Also see discussion under "Gear Cutter Sharpening Attachment").

The clearance angle is the most important consideration when grinding a milling cutter which is included in the first class. New cutters should be sharpened before they are used, because the clearance angle may not be correct for the material to be machined.

Chatter in the finish milled surface may be caused by an incorrectly ground cutter, or by a poorly designed cutter. It may also be due to the shape of the part being milled; method of clamping the work; type of fixture. locating points and pads; and finally, the condition of the milling machine on which the job is milled. The cutter clearance angles for the more important materials given on the following page should be used as a starting point. If chatter appears, check the clearance angle and then investigate the other factors mentioned above. It is possible that a little more or a little less clearance angle may eliminate chatter.

## CUTTER CLEARANCE ANGLES

In any case, the determination of the exact clearance angles which produce the best finish and the greatest number of pieces per sharpening is a "cut and try" proposition. After you have once found the best clearance angles for a particular job, then write down the part number of the work-piece, the part number of the cutter, and the clearance angles, so that you can duplicate the results.

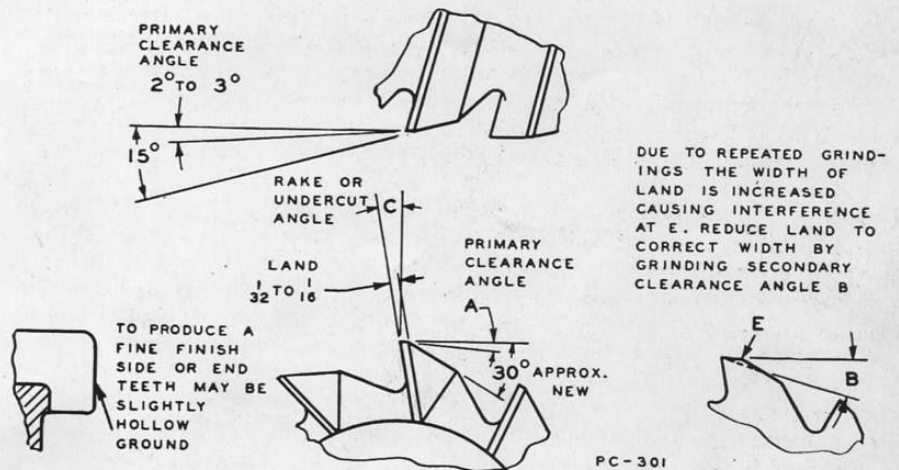


Fig. 8  
Clearance Angle Sketch of a Solid Milling Cutter

### Approximate Clearance Angles For Milling Cutters

MATERIAL To be Machined	Primary Clearance Angle—A	Secondary Clearance Angle—B	Rake Angle—C
Alloy Steel.....	3°	6°	15°
Mild Steel.....	5°	8°	15°
Cast Iron.....	7°	10°	8° to 10°
Aluminum.....	10°	13°	10°
Brass.....	10°	13°	10°

Sketches of inserted cutter teeth are shown in Fig. 9. The enlarged section of the blade indicates three grindings for the corners of the teeth, producing an approximate radius of  $\frac{1}{8}$ ". An approximate radius is obtained by first grinding to a  $45^\circ$  angle, then to  $22\frac{1}{2}^\circ$ , then to  $67\frac{1}{2}^\circ$ . This method of grinding the corners is satisfactory for small quantities of the work-piece to be machined. However, if a great many pieces per sharpening is important, we recommend a true radius for the corner, which can be obtained by using our Radius Grinding Attachment, illustrated on page 49.



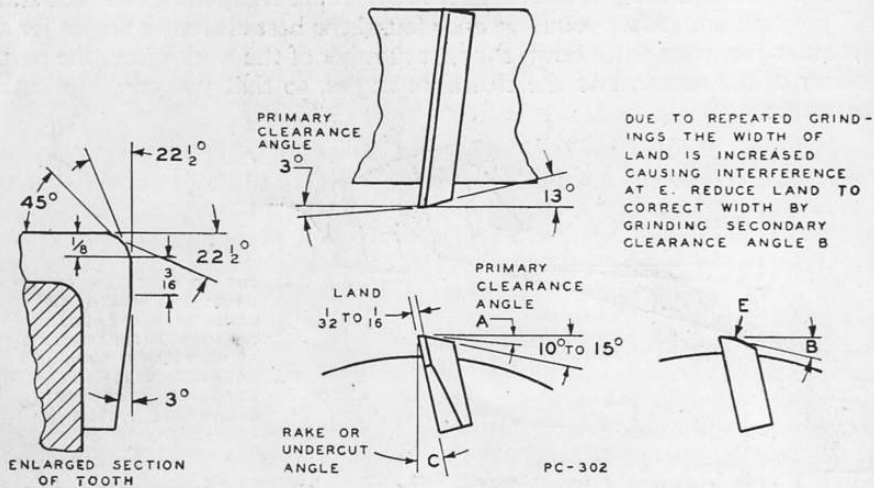


Fig. 9  
Clearance Angle Sketch of an Inserted Tooth Cutter

## GRINDING CUTTERS

### Without the Use of Attachments

A variety of types of cutters can be ground on the Cincinnati No. 2 Cutter Grinder without the use of attachments; that is, by using only the standard work head and tailstocks. A partial list of these cutters is as follows:

- |                       |                              |
|-----------------------|------------------------------|
| Spiral Mills          | Angular Cutters              |
| Spiral End Mills      | Face Mills up to 8" diameter |
| Shell End Mills       | Saws up to 8" diameter       |
| Slotting Cutters      | Form Milling Cutters         |
| Keyway Cutters        | Taps                         |
| Stagger Tooth Cutters | Hobs                         |
| Side Milling Cutters  | Reamers                      |

## TOOL ROOM

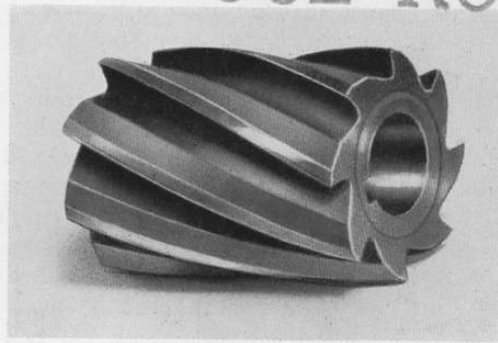


Fig. 10  
Spiral Milling Cutter

**Grinding a Spiral Mill.** We will go through the various steps necessary in setting up for and grinding a spiral mill, since the method of sharpening all cutters of the first class is essentially the same except the slight differences as noted. These steps are given in detail and therefore seem rather long, but the total time required for this cutter grinder set-up is surprisingly short because of the convenience in making the various adjustments.

1. Fasten the wheel, shape No. 23, to the right hand end of the wheel spindle. Swivel the wheel head 89 degrees. (Fig. 11)
2. Set the column to zero. (Fig. 11)
3. Mount the plain tooth rest holder with the rounded or off-set blade on the wheel head, locating the blade in front of the rim of the wheel. Allow the tooth rest stem to hang loose. Move the saddle away from the wheel to allow about  $1\frac{1}{2}$ " clearance between the face of the wheel and the cutter. (Fig. 11)
4. Clamp the right hand and left hand tailstocks in position according to the length of the arbor or mandrel. (Fig. 12)
5. Place the cutter and a dog on a mandrel and place the mandrel between centres, inserting the dog in the clearance setting dial on the left hand tailstock. (Fig. 12)

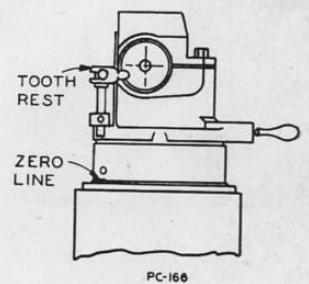


Fig. 11  
Steps 1, 2 and 3 in Set-up  
for Grinding a Spiral Mill

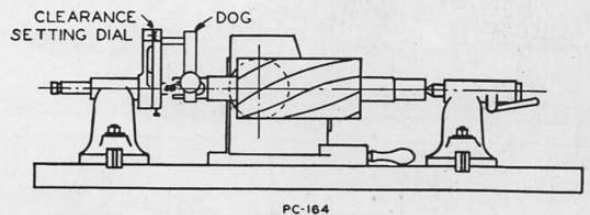
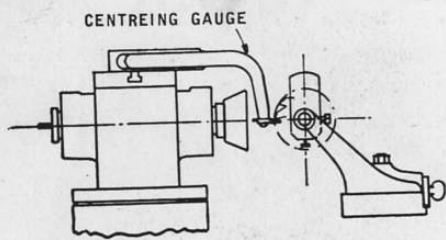


Fig. 12  
Steps 4 and 5 in Set-up for Grinding a Spiral Mill

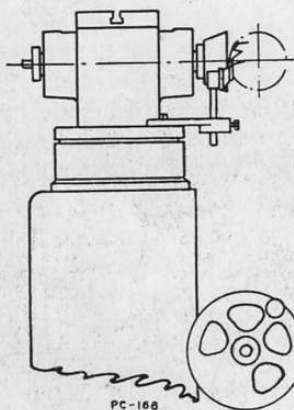


PC-165

Fig. 13

Steps 6 and 7 in Set-up for Grinding a Spiral Mill

6. Set and lock the clearance setting dial at zero.
7. Set the centreing gauge on top of the wheel head in front of the rim of the wheel. Move the slide until the cutting edge of one tooth touches the gauge. Mark this spot where gauged, so it can be returned to the same point if accidentally moved. (Fig. 13)



PC-166

Fig. 14

Step 8 in Set-up for Grinding a Spiral Mill

8. Move the saddle in until the cutter tooth is close to the wheel, place the tooth rest blade under the tooth, and clamp. (Fig. 14)
9. Unlock the clearance setting dial and read the desired clearance angle by lowering the wheel head and rotating the cutter by hand against the tooth rest. (Fig. 15)
10. Remove the setting dog and grind, holding the cutter by hand against the tooth rest. (Fig. 15)

After grinding the cutting clearance, test the cutter with a micrometer to see that it has been ground parallel. Re-set and grind the secondary clearance, using the same method as outlined above.

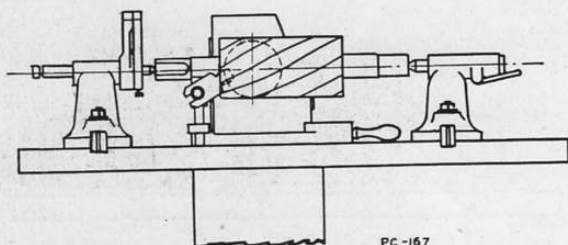


Fig. 15

Steps 9 and 10 in Set-up for Grinding a Spiral Mill

Notice that the flare cup wheel is shown in the illustrations for the above grinding set-up. This type of wheel is shown because it produces a flat instead of curved land produced by the disc wheel, and it is the type preferred by most operators. However, these instructions are the same for a disc wheel, if this type is preferred.

**Grinding a Spiral or a Shell End Mill.** Much the same practice is carried out when grinding a spiral or shell end mill as when grinding an ordinary spiral milling cutter. The main difference is that the ends or face of the teeth and the corners must also be sharpened, requiring two additional set-ups.

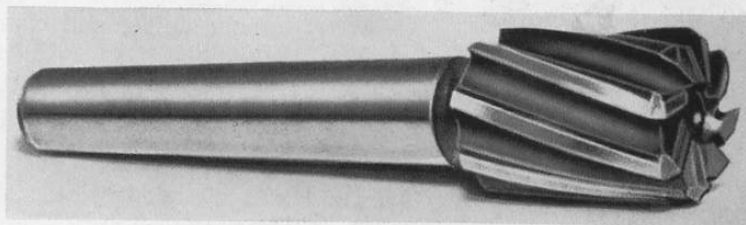


Fig. 16  
Spiral End Mill

After grinding the periphery of the teeth, proceed as follows to set up for \*grinding the face of the teeth. (Fig. 18)

1. Place the work head in position on the table. Insert the cutter in the work head.
2. Fasten wheel shape No. 23 to the right hand end of the spindle, true the wheel, and swivel the wheel head  $89^\circ$ .
3. Place the centreing gauge on top of the wheel head, and raise the wheel head a sufficient amount to bring the cutting edge of a tooth in a horizontal plane with the gauge; which at the same time centres the cutting edge of the tooth with the centre of the wheel.

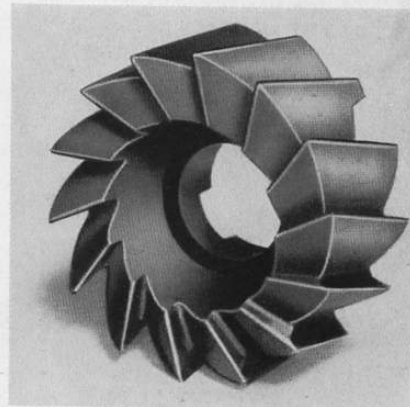


Fig. 17  
Shell End Mill

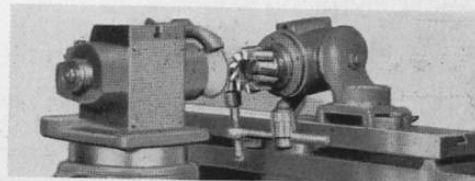


Fig. 18  
Grinding the Faces of the Teeth of a  
Shell End Mill

\*These instructions are for a right hand cutter with undercut teeth.

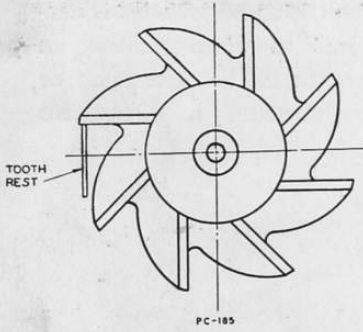


Fig. 19

TOOTH REST Blade in Position for Right Hand Mill

4. Lock the work head spindle in place.
5. Clamp the tooth rest in place on the work head (see Fig. 19), resting the blade against the under side of the tooth to be ground.
6. Swivel the cutter downward to the desired clearance angle, and clamp in position.
7. Lower the wheel head so that the tooth next to the one being ground will clear the wheel.
8. Loosen the work head spindle thumb screw, and proceed to grind.

Re-set for the secondary clearance and grind, using the same procedure as outlined above. On large diameter shell end mills, it may be advantageous to back off the faces of the teeth towards the centre of the cutter, similar to the tooth of a face mill, Fig. 9. An angle of about  $4^\circ$  is sufficient, allowing a land of  $\frac{3}{16}$ " to  $\frac{5}{16}$ " long.

It is important that as much care be used when grinding the corners of the teeth as when grinding the face or periphery; otherwise the cutting edges will dull rapidly, and a poor finish will be obtained.

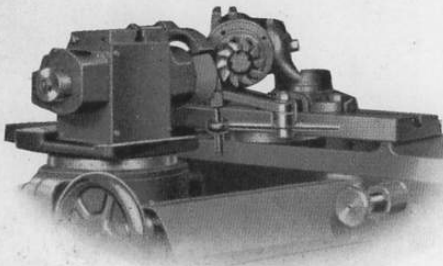


Fig. 20

Grinding the Corners of the Teeth of a Shell End Mill

To grind the corners, proceed as follows:

1. Swivel the work head in the horizontal plane to  $45^\circ$ , as shown by the graduations on the base.
2. Bring the upper part of the work head back to zero on the degree readings.
3. Set the column to zero. Place the centring gauge on top of the wheel head. Move

the slide and rotate the cutter until the corner of one tooth just touches the gauge. Lock the work head spindle in place with the thumb screw

4. Set the clearance setting dial to zero. Loosen the spindle clamping thumb screw and rotate the cutter by hand until the clearance setting dial indicates the desired clearance angle. Lock the work head spindle in place.

**Note**—The tooth rest set-up for some types of face and corner sharpening operations will be more rigid and simplified if the work head is elevated with a 2" raising block. (Obtainable at extra cost.)

## GRINDING CUTTERS

5. Clamp the tooth rest in place on the work head, resting the blade against the under side of the tooth to be ground. (See Fig. 19.)
6. Swivel the cutter downward to the same clearance angle as indicated on the clearance setting dial.
7. Loosen the work head spindle clamping thumb screw, and adjust the saddle to bring the cutter in position with the wheel.
8. Set the dog on the slide for the proper length of stroke, and proceed to grind.

**Note**—The two angular settings given in steps 4 and 6 are necessary because we are grinding part of the diameter and part of the face of the teeth.

The above instructions are for a right hand mill with undercut teeth.

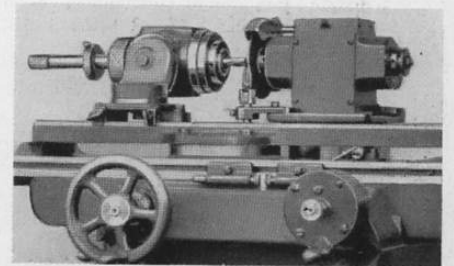
If the teeth are radial, set the column to zero when grinding the ends of the teeth, and the cutting edge of the tooth will be aligned with the horizontal plane through the centre of the wheel and the cutter.

If the cutter is left hand, the set-up for grinding the ends of the teeth is the same as outlined above, except for the changes in the following steps. Of course, the wheel is placed on the left hand end of the spindle, and the duplicate controls at the right hand rear are used.

3. Loosen the screw through the gauge tip end, and swivel it 180°. Lower the wheel head to bring the cutting edge of the tooth in a horizontal plane with the gauge.
6. Tilt the work head up to the required clearance angle, and clamp in place.
7. Raise the wheel head so that the bottom of the rim of the wheel will clear the tooth next to the one being ground.

### Grinding Small Spiral End Mills.

The table is locked against movement when the small end mill grinding attachment is used. The work head spindle is also locked in position. A bar, which slides in a sleeve inserted in the No. 12 B. & S. taper bore of the work head spindle, has a No. 7 B. & S. taper bore in the front end for holding small diameter end mills. This bar is moved axially and rotated by hand. A stop collar is secured to the bar to govern its length of travel. Adjust for the clearance angle by using the dial on the work head spindle.



**Fig. 21**  
Small End Mill Grinding Attachment  
(Supplied on Demand at Extra Cost)

**Grinding a Keyway or Slotting Cutter.** When grinding this type of cutter, practically the same set-up is used as for grinding spiral mills, except that the tooth rest is clamped to the work head.

**Grinding a Side Milling Cutter.** Fig. 22 shows the outline of a side milling cutter; that is, one which cuts with the sides as well as the periphery of the teeth. Notice that  $12^\circ$  is recommended for the secondary clearance angle on this type of cutter rather than  $30^\circ$  as listed in the table on page 15. This difference is due to the fact that the sides of the teeth have the same clearance angles as the periphery, and therefore would be weakened too much with a large secondary clearance angle. Since the only function of the secondary clearance is to keep the heel

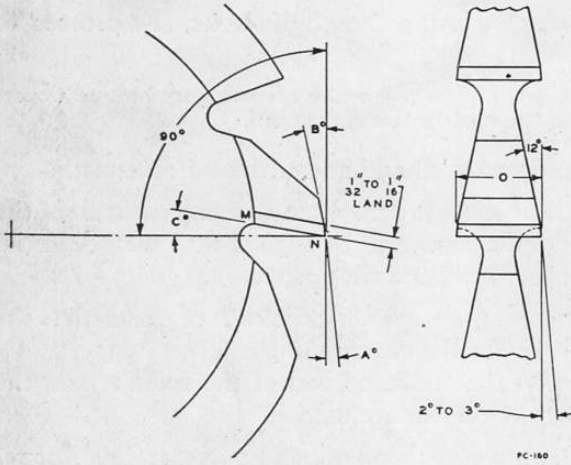


Fig. 22  
Side Milling Cutter

of the tooth from dragging, it is often well to favor the smaller angles.

After grinding the periphery of the teeth in the regular manner, set up for grinding one side of the teeth in the same manner as described under grinding shell end mills; then grind the other side of the teeth.

This type of cutter often shows a tendency to chatter. To correct this fault, the cutting clearance on the sides of the teeth can be reduced to as low as  $1^\circ$ , especially if very little cutting is being done by the sides. As an additional remedy, the cutter can be slightly "hollow" ground; that is, the width "O" is made less at "M" than at "N". To accomplish this result, swivel the work head about  $\frac{1}{2}^\circ$  when grinding the sides.

**Grinding a Stagger Tooth Cutter.** A stagger tooth cutter is one which has alternate side rake in opposite directions, and with teeth whose cutting edges are about half the width of the cut (Fig. 23). The teeth are usually provided with a cutting edge on the sides, similar to a side milling cutter.

Although the cutter has right and left hand spiral teeth, it is ground at one setting; the operations being similar to grinding an ordinary spiral mill.

Use the tooth rest blade with a rounded top so that the teeth can slide over the blade regardless of the alternate right and left hand spiral. The set-up is practically the same as for a spiral mill.

**Grinding an Angular Cutter.** Grinding an angular cutter is very similar to grinding a shell end mill except that the work head is swiveled to the angle of the cutter. If the cutter has spiral teeth, the tooth rest must be fastened to the wheel head, but if it has straight teeth, the tooth rest may be fastened to the work head if it is impossible to fasten it to the wheel head. When the tooth rest is fastened to the work head, the clearance angle is obtained by tilting the head the desired number of degrees, and then using the centreing gauge and lining up one tooth parallel to the horizontal plane. (See Fig. 24)

Adjust the table to the approximate angle by taking a trial grinding cut across the tooth of the cutter. If the angle must be exact, check it with a gauge, and re-grind if necessary.

**Grinding Small Diameter Face Mills.** Grinding a small diameter face mill of 8" diameter or less, using the work head as the cutter support, is essentially the same as grinding a shell end mill. The angles for grinding the teeth of a face mill are shown in Fig. 9. The cup wheel, shape No. 23, is used for all operations. A special arbor which will accommodate face mills of standard design is supplied on order as extra equipment.

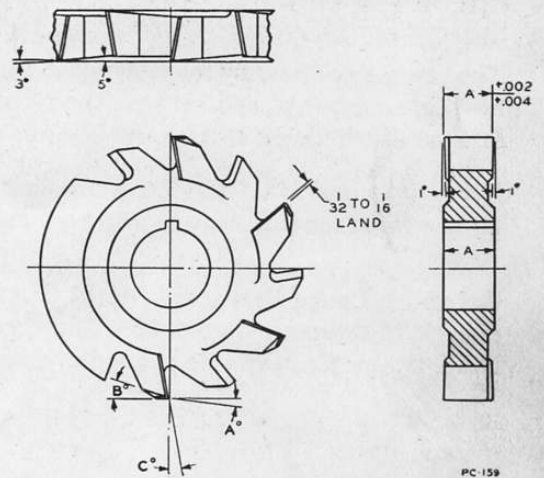


Fig. 23  
Stagger Tooth Cutter

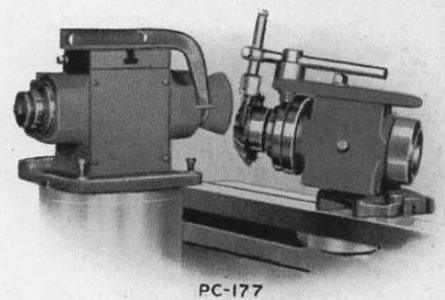


Fig. 24  
Setting Up for Grinding an Angular Cutter.  
Be Sure to Mount Wheel Guard in Position  
After Set-up is Completed



# TOOL ROOM

**Grinding Small Diameter Metal Cutting Saws.** Metal cutting saws of 8" diameter or less may be ground without the use of special attachments.

The saw may be held by the stud which fits into the work head, or it may be held on an arbor placed between the tailstock centres. In either case, the method of grinding is essentially the same as for an ordinary slotting cutter.

Use a cup wheel when grinding a saw, and lower the wheel head far enough for the tooth next to the one being ground to clear the top of the wheel.

**Grinding Large Diameter Metal Cutting Saws.** Metal cutting saws above 8" diameter and up to 48" diameter may be ground on the Cincinnati No. 2 Cutter Grinder with the aid of a special flange and collar which you can easily make on a lathe. If desired, we will make this equipment for you on special order.

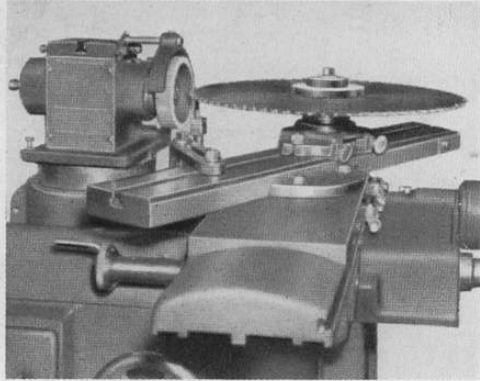


Fig. 25  
Grinding the Teeth of a Large Metal Cutting Saw

In the illustrations, the bottom part of the Surface Grinding Attachment (Fig. 50) supports the saw, which in turn is centred on a special stud and clamped with a large washer. The following general procedure is required to set up.

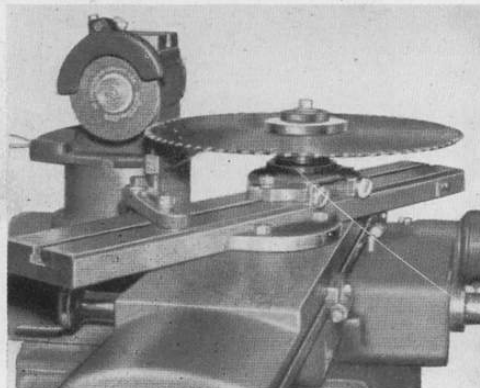


Fig. 26  
Grinding a Bevel on the Alternate Teeth of a Large Metal Cutting Saw

1. Mount wheel shape No. 24 on the spindle.
2. Clamp the work supporting and centreing parts to the table.
3. Draw a line across the saw through its centre.
4. Place the saw over its centreing stud, and clamp just firm enough to rotate by hand.
5. Adjust the column to a convenient height for grinding, and clamp in position.

6. If the saw is too large to grind with the table in the normal position, swivel the table a sufficient amount to allow the saw to pass the wheel. (Fig. 25)
7. Set your bevel protractor to  $95^\circ$  and place it on the saw with one edge on the centre line which was drawn. (This setting of the protractor will give you a  $5^\circ$  clearance angle.)
8. Now swivel the table until the other edge of the protractor is parallel with the face of the wheel. Clamp the saw in this position.
9. Clamp the tooth rest to the table, as illustrated.
10. Loosen the clamping collar enough to allow the saw to turn on its stud, and proceed to grind.

On large diameter saws it is good practice to bevel off the corners of alternate teeth as illustrated in Fig. 26. Use the disc wheel, shape No. 28, or the dish wheel, shape No. 21, raise the wheel head far enough above the centre line of the wheel to give the amount of bevel desired and grind every second tooth. To grind the alternate teeth on the other side, turn the saw over and proceed as before.

**Grinding the End Teeth of Long End Mills.** End mills which are too long to grind the ends of the teeth in the conventional manner may be ground by using the set-up illustrated in Figure 27. Up to 8" flute length may be accommodated in this manner, as compared to approximately  $4\frac{1}{4}$ " with the regular table setting and  $7\frac{1}{2}$ " with the table swiveled  $180^\circ$ . The actual grinding procedure is the same as for short end mills.

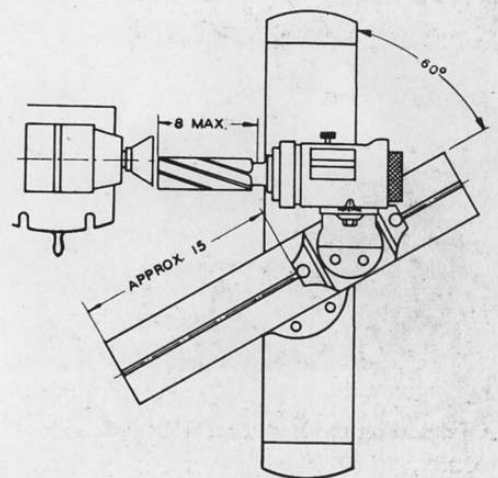
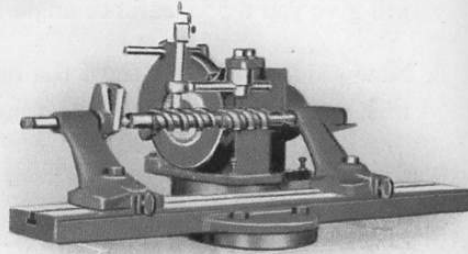


Fig. 27  
Set-Up for Grinding the Ends of the  
Teeth of Long End Mills

**Grinding a Helical Cutter.** The set-up for grinding a helical cutter is listed in detail because it is different than any other type. (See Fig. 28)

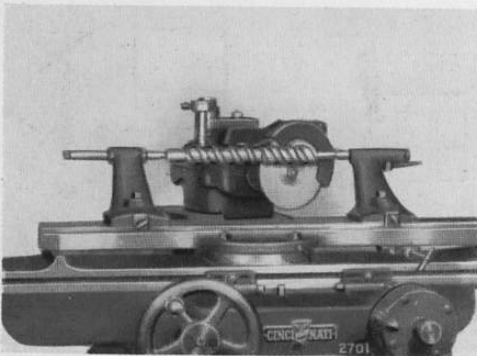
1. Fasten an 8" diameter disc wheel (similar to the one supplied with the face mill attachment) to the end of the spindle.
2. True it with the diamond truing attachment.
3. Swivel the wheel head to the desired clearance angle. (See table, page 27. For example, if the cutter has a 40° helix, and you want to grind a 5° clearance angle, swivel the wheel head to 3¼°.)



PC-174

**Fig. 28**  
**Grinding the Periphery of a Helical Cutter**

4. Insert the shank end of the cutter in the taper hole of the \*guide, and place both between the tailstock centres.
5. Set the column to zero. Move the saddle towards the wheel to bring the cutter in position.



**Fig. 29**

**Grinding the Face of a Helical Cutter**

6. Fasten the tooth rest holder to the top of the wheel head, with the stem of the holder in the slot of the guide. Any piece of cold rolled steel the same diameter as the width of slot in the guide may be used; or the tooth rest blade may be used if a little care is exercised.
7. Adjust the wheel to the work and grind.

There should be ample clearance between the ends of the cutter teeth and the end of the guide grooves to allow the tooth rest to clear the groove when indexing to the next tooth.

**\*Note**—A guide with the same helix angle, and slightly longer than the cutter, must be provided for grinding each helical cutter.

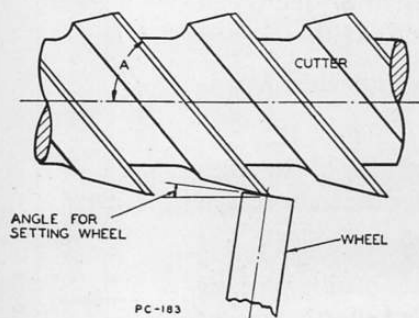


Fig. 30  
Angular Setting of Wheel for  
Helical Cutters

ANGLE FOR SETTING WHEEL TO  
OBTAIN CLEARANCE ANGLE  
OF 3° TO 10° ON HELICAL CUTTERS

Helix Angle "A"	CLEARANCE ANGLE DESIRED							
	3°	4°	5°	6°	7°	8°	9°	10°
30°	1½	2	2½	3	3½	4	4½	5
35°	1¾	2¼	3	3½	4	4½	5¼	5¾
40°	2	2½	3¼	4	4½	5¼	5¾	6½
45°	2	2¾	3½	4¼	5	5¾	6½	7¼
50°	2¼	3	3¾	4½	5½	6¼	7	7¾
55°	2½	3¼	4	5	5¾	6½	7½	8¼
60°	2½	3½	4¼	5¼	6	7	7¾	8¾
65°	2¾	3¾	4½	5½	6½	7¼	8¼	9
70°	2¾	3¾	4¾	5¾	6½	7½	8½	9½
75°	3	3¾	4¾	5¾	6¾	7¾	8¾	9¾

**Grinding a Tap.** The set-up for grinding a tap (Fig. 31) and grinding a radial tooth form milling cutter are essentially the same, since they are both straight tooth form relieved cutters. The various steps in making the set-up are as follows:

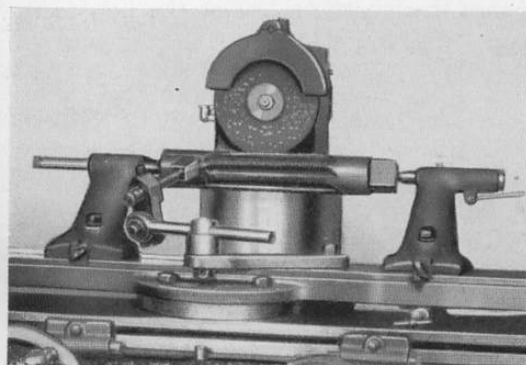


Fig. 31  
Grinding a Tap

1. Fasten the extension and the dish wheel (shape No. 21) to the left hand end of the spindle.
2. Shift the belt to the small step of the pulley.
3. Swivel the wheel head 90°
4. True the wheel with a diamond.
5. Place a long straight-edge across the face of the wheel, and line up with the tailstock centres.

A simple gauge can be made for this operation at little expense. (Fig. 32)

6. Place the tap between centres.

**Note**—When grinding a tap, the tooth rest set-up will be more rigid and simplified if it is elevated with a 2" raising block. (Obtainable at extra cost.)

7. Fasten the tooth rest to the table, with the square end blade against the back of the tooth to be ground.
8. Adjust the tap to the wheel with the micrometer adjustment on the tooth rest, and grind.

To produce accurate results in grinding, the backs of the teeth should be ground before grinding the faces, for the same reason as described under "Gear Cutter Sharpening Attachment".

The teeth must be ground radially in cutters of this type, or the tooth form will be changed. A simple and effective means of testing is shown in Fig. 33. The block is exactly  $4\frac{7}{8}$ " high, the same height as the tailstock centres. Set the indicator dial to zero when indicating this block, then remove the block and turn the cutter until the outer edge of the tooth touches the indicator pointer and registers zero on the dial. Then move the indicator straight in towards the centre of the cutter, and note the reading. If the tooth is ground radially, the indicator will remain at zero.

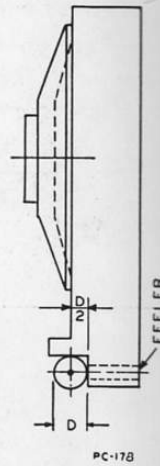


Fig. 32  
Gauge for Centreing Face of Wheel with Centre of Work

**Grinding a Hob.** Grinding a hob is similar to grinding a tap or form milling cutter, except the difference due to the spiral of the hob teeth. Proceed as follows when setting up. (See Fig. 34)

1. Fasten the extension to the left hand end of the spindle, and place a 6" wheel about  $\frac{1}{2}$ " wide in position.
2. Swivel the wheel head to  $77\frac{1}{2}^\circ$  and true the wheel with a diamond. This setting gives a  $12\frac{1}{2}^\circ$  taper to the wheel, and allows a line contact when grinding. See page 44 for special truing attachment. Touch up the sharp corner of the wheel with a carborundum stick.

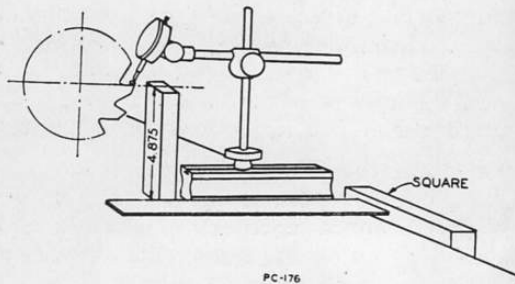


Fig. 33  
Testing the Accuracy of Grinding a Radial Tooth Form Cutter

3. Swivel the wheel head to the angle of spiral of the hob teeth and clamp.
4. Clamp the two tailstocks in position, about the correct distance apart for the arbor.

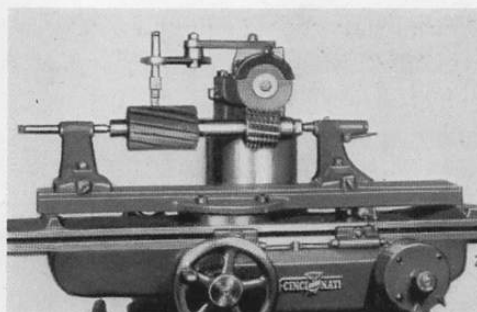


Fig. 34  
Grinding a Hob

5. Place the hob and guide on an arbor, and set between centres. (A guide of the same spiral angle as the hob must be used when grinding.)
6. Adjust the saddle and column until the front face of the hob teeth are parallel with the angular edge of the wheel.
7. Clamp the tooth rest to the wheel head with the blade against one tooth of the guide.
8. First take a trial cut. A small amount of red lead smeared across the face of the tooth will help you determine whether or not the wheel is cutting the full width of the face. Adjust the hob tooth to the wheel with the micrometer tooth adjustment, and grind.

After grinding, test the hob teeth with an indicator to see that they have been ground radially. (See Fig. 33)

### GRINDING A REAMER

When grinding a milling cutter on the Cincinnati No. 2 Cutter Grinder, the clearance angle is obtained by merely centring the work with the grinding wheel spindle and then revolving the cutter through the proper number of degrees as read from the dial on the work head. The accuracy of the clearance angle depends upon the accuracy with which the lines on the setting dial have been matched. It is impossible to match such lines with a high degree of accuracy, but an error of a few minutes in the clearance angle of a *milling cutter* does not perceptibly affect the results.

However, the clearance angle of a *reamer* must be correct within a few minutes, or it will not make a good finish in the hole. Since the accuracy required cannot be obtained by matching the degree lines on the dial readings, we recommend the vertical adjustment system explained below.

Two settings are required to obtain the desired "land". First, the vertical adjustment necessary to grind the proper clearance angle; and second, the vertical adjustment necessary to grind off the heel of the blade and bring the "land" to the desired width.

By "vertical adjustment" we mean that the wheel head should be lowered the amount given in the tables, pages 63 and 64. The tooth rest need be set only once, but it must be placed on the grinding wheel head, so that when this unit is lowered it will bring the tooth rest away from the blade and allow the reamer to turn through the proper clearance angle.

The following general operations are required for sharpening a reamer:

1. Notice the zero mark on the column. Match it with the top of the finished casting and set the dial on the elevating crank to zero.
2. Fasten the tooth rest on the grinding wheel head so that the blade is directly in front of the rim of the wheel, allowing the tooth rest stem to hang loose.
3. Place the centreing gauge on the table. Adjust the tooth rest blade under the gauge. The tip of the blade is now central with the centre of the grinding wheel and the tail stock centres.

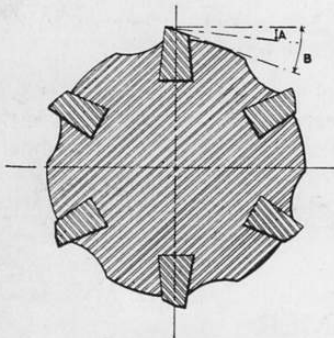


Fig. 35  
Section Through an Inserted  
Blade Reamer

4. Place the reamer between centres.
5. Bring the cutting edge of one tooth against the tooth rest.
6. Lower the wheel head the amount required for the cutting clearance as given in the table. (Pages 63 and 64):
7. Revolve the reamer to again bring the blade against the tooth rest and then proceed to grind the cutting clearance "A". Grind the straight as well as the front and rear taper portions at this setting.
8. Lower the wheel head the amount required for the secondary clearance "B", as given in the table (pages 63 and 64).
9. Again bring the reamer blade against the tooth rest, and finish grinding the reamer by backing off the blade until the "land" of the cutting edge is the width shown in the tables.

If the cutting clearance is to be produced by the cylindrical grinding method, (Fig. 38) then the centres of the work and wheel must be in the same plane with the centreing gauge. Of course, it is then unnecessary to use the tooth rest.

### HAND REAMERS

The cutting edge of a hand reamer blade may be considered as divided into three parts: the front taper part which removes most of the metal and allows the reamer to enter the hole freely; the straight part which does the finish cutting and brings the hole to the required finish and diameter; and the rear taper part which prevents the hole from being marred when the reamer is removed. (Figs. 36 and 37)

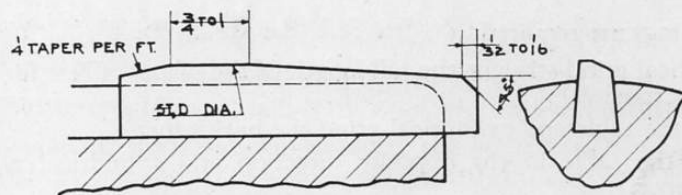


Fig. 36  
Profile of a Hand Reamer Blade

The length of the front taper should be as long as possible, depending upon the length of the blade, and it should be ground to a taper of about  $\frac{1}{64}$ " per foot, depending upon the amount of metal to be removed. The straight part of the reamer should be about  $\frac{3}{4}$ " to 1" long, and should be ground to the exact diameter of the hole to be reamed. The rear taper part should be about  $\frac{1}{4}$ " long and ground to a taper of  $\frac{1}{4}$ " per foot.

The beveled corner on the end of the blade is provided when the reamer is made. It does no cutting, but simply eliminates the sharp corner at this point, and therefore requires no special care when grinding.

After grinding a hand reamer, the cutting edge may be touched up with an oil stone; just enough to remove the grinding wheel marks.



Fig. 37  
Hand Reamer

### Grinding a Hand Reamer for Steel.

#### FIRST OPERATION—Grinding the cutting clearance

Since the "land" for this type of reamer is only .006" to .008" wide, the cutting clearance can be ground by the cylindrical method. This method of grinding the cutting clearance for these reamers is recommended because it is much faster, and the finish obtained in the hole is just as good as that made by a reamer ground in the ordinary way.

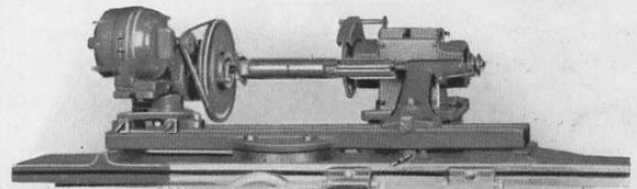


Fig. 38  
Cylindrical Grinding the Cutting Clearance on a Hand Reamer

Set up the cylindrical grinding attachment (see page 38) and place the reamer between centres, using the universal driving dog on the shank end of the reamer. It is very important that the reamer centres be clean, or better still, they may be lapped to insure a good job. Place wheel shape No. 25 on the grinding wheel spindle, set the column to zero, and lock in place. Be sure that the rotation is such that the heel of the blade strikes the grinding wheel first; otherwise there will be no cutting clearance (Fig. 38). Use the front hand table feed for moving the reamer past the wheel.



# TOOL ROOM

Three settings are required:

1. Cylindrical grind straight the full length of the blade. (Test for parallel with micrometer).
2. Swivel the table and cylindrical grind the back taper.
3. Swivel the table in the opposite direction and cylindrical grind the front taper.

**SECOND OPERATION—Grinding the Secondary Clearance (Fig. 39)**

Two separate settings are required, but each reamer blade must be ground separately, similar to grinding a milling cutter. Use the figures in the second column under Table 1 (pages 63 and 64) for this operation. For the standard stock removal of .002", the blade should be backed off until the "land" is .006" to .008" wide. If more than .002" stock is to be removed, the

"land" can be somewhat wider; and if the hole is very large, it may be advisable to use two hand reamers—a roughing and finishing.

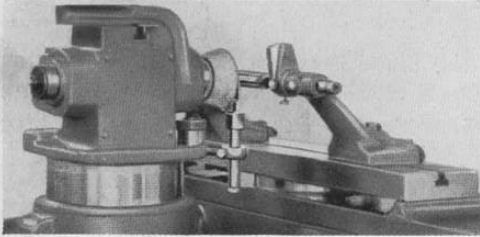


Fig. 39

Setting Up for Grinding the Secondary Clearance on a Hand Reamer. Be Sure to Mount Wheel Guard in Position After Set-up is Completed

The settings are as follows:

1. Grind the secondary clearance on the front taper part.
2. Swivel the table to zero and grind the secondary clearance on the straight part. (See tables).

If it is necessary to bevel the corners, attach the tooth rest to the table, swing the table to an angle of 45°, and set the dogs on the slide to limit the stroke. Disengage the table feed crank and use the rear knob control, holding the reamer against the blade with the other hand. (Fig. 40).

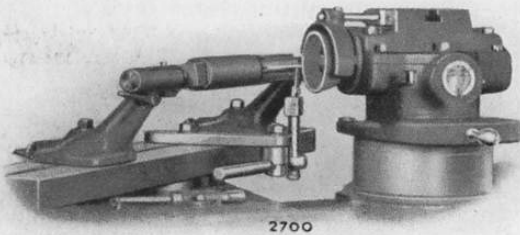


Fig. 40

Beveling the Corners of the Blades on a Hand Reamer

**Grinding a Hand Reamer for Cast Iron or Bronze.** When grinding a hand reamer for cast iron or bronze, the cutting clearance cannot be ground with the cylindrical grinding attachment, because the clearance required is too great, and the reamer will not cut as well as when each blade is ground separately.

After setting up the machine with the cup wheel, two operations are required:

**FIRST OPERATION—Grinding the cutting clearance**

1. Grind straight the full length of the reamer. (See tables on pages 63 and 64—Test for parallel with micrometer).
2. Swivel the table and grind the back taper part.

## GRINDING REAMERS

3. Swivel the table in the opposite direction and grind the front taper part to a taper of about  $\frac{1}{8}$ " per foot.

### SECOND OPERATION—Grinding the Secondary Clearance or Backing Off

For the standard stock removal of .002", the blade of a hand reamer for cast iron or bronze should be backed off until the "land" is .020" to .025" wide.

1. Grind the secondary clearance on the front taper part.
2. Set the table to zero and grind the secondary clearance on the straight part. (See tables).

## CHUCKING OR MACHINE REAMERS

**Grinding a Chucking Reamer for Steel.** Two reamers, a roughing and a finishing reamer, are usually employed to finish the hole in a steel part if a good finish is required, as for a bearing. If the finish requirements are not so exact, as a hole which has a bronze bushing pressed into it, then only one reamer is required.

*Roughing Reamer.* The profile of a blade in a roughing reamer for steel is shown in Fig. 42. The reamer may be solid or inserted blade, but for small diameters a solid reamer is generally used. The straight part should be ground about .002" less than the required diameter of the hole. Since the beveled corner in front does most of the work, it should be given a generous clearance angle to avoid any drag on the heel of the blade.

The figures given in the following settings are for a roughing reamer which will remove up to  $\frac{1}{32}$ " stock. It should be noted that a new solid reamer is about .004" oversize, which makes it necessary to grind the outside diameter of the teeth before using.



Fig. 41  
A Solid Roughing Reamer for Steel

### FIRST OPERATION—Grinding the Secondary Clearance or Backing Off

This operation differs slightly from the set-up for grinding reamers given on page 30 because a dish wheel (shape No. 21) is used throughout, to avoid changing when setting up for grinding the corners.

1. Set the column to zero.
2. Fasten wheel shape No. 21 to the grinding wheel spindle.
3. Raise the wheel head .650" to .700" for the heel clearance.

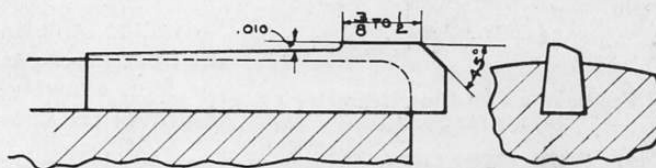


Fig. 42  
Profile of a Roughing Reamer Blade for Steel

4. Clamp the tooth rest in position *on the table*, allowing the tooth rest stem to hang loose. Place the centring gauge on the table in front of the wheel, and bring the tooth rest blade up under the gauge and clamp.
5. Place the reamer between centres, and bring the cutting edge of one tooth against the blade.
6. Proceed to grind the blades their full length, allowing a land of about .015".

**SECOND OPERATION—Grinding the Cutting Clearance**

Cylindrical grind the cutting clearance to the desired diameter, similar to grinding the cutting clearance on a hand reamer for steel. The rotation of the wheel and reamer must be such that the heel of the reamer blade strikes the wheel first, in order to produce cutting clearance.

**THIRD OPERATION—Grinding the Blade Relief**

Cylindrical grind the back end of the blades about .020" smaller than the hole diameter, allowing about 1/2" length of cutting blade.

**FOURTH OPERATION—Grinding the Corners**

Swivel the table to 45° and grind the corners, using the same wheel head setting as for grinding the secondary clearance.

*Finishing Reamer.* The profile of a blade for a finish machine reamer for steel is shown in Fig. 44. These finishing reamers are different from the roughing reamer in that the cutting is done by the front taper part of the blade, and not by the corner. Two to six thousandths should be removed from the diameter of the hole by the finishing reamer. Two operations, using wheel shape No. 25, are required when grinding.

**FIRST OPERATION—Grinding the Cutting Clearance**

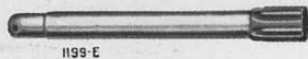


Fig. 43  
An Inserted Blade Finishing Reamer for Steel

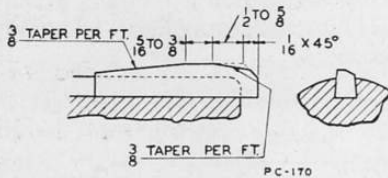


Fig. 44  
Profile of a Finishing Reamer Blade for Steel

Cylindrical grind straight the cutting clearance the full length of the blade. Again we call attention to the fact that the heel of the reamer blade must strike the wheel before the cutting edge, in order to produce a clearance.

2. Swivel the table and cylindrical grind the back taper part to a taper of 3/8" per foot.
3. Swivel the table and cylindrical grind the front taper part to a taper of 3/8" per foot, allowing about 5/16" to 3/8" length for the straight part.

**SECOND OPERATION—Grinding the Secondary Clearance or Backing Off**

Back off the blade until the land is .006" to .008" wide.

1. Back off the front taper part.
2. Swivel the table straight and back off the straight part. (See tables).

**Grinding a Chucking Reamer for Cast Iron.** The profile of a chucking or machine reamer for cast iron is the same as a finish machine reamer for steel, shown in Fig. 44. The figures given in the illustration are for a reamer which is to remove .005" to .015" from the hole, depending upon the diameter. After setting up the machine as described on page 30, two operations are required, using the cup wheel, shape No. 23.

**FIRST OPERATION—Grinding the Cutting Clearance**

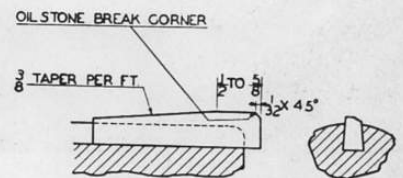
1. Grind straight the full length of the reamer.
2. Swivel the table and grind the back taper part.
3. Swivel the table in the opposite direction and grind the front taper part.

**SECOND OPERATION—Grinding the Secondary Clearance or Backing Off**

Back off the blade until the land is .015" to .020" wide.

1. Back off the front taper part.
2. Swivel the table straight and grind the straight part.

**Grinding a Chucking Reamer for Bronze.** The profile of a machine reamer for bronze is shown in Fig. 45. Note that the corners of the teeth do most of the cutting, similar to a roughing reamer for steel. The figures given in the illustration are for a reamer which is to remove .005" to .015" from the hole, depending upon the diameter. Three operations are required for grinding.



PC-171

Fig. 45  
Profile of a Machine Reamer  
Blade for Bronze

**FIRST OPERATION—Grinding the Cutting Clearance**

1. Grind straight the full length of the blade.
2. Swivel the table and grind the rear taper part.

**SECOND OPERATION—Grinding the Secondary Clearance or Backing Off**

Back off the blade until the land is .015" to .020" wide.

1. Swivel the table straight and back off the straight part.

**THIRD OPERATION—Bevel off the corners of the blades**

Grind the corners of the blades, using the same method as outlined for grinding the corners of the blades of a roughing reamer for steel. After the above grinding operations are complete, oilstone the corner of the blade to a slight radius as indicated. (Fig. 45)

## TAPER REAMERS

**Grinding a Taper Reamer.** A little more care must be used when grinding a taper reamer than when grinding a straight reamer, because there are two considerations instead of one; the taper, and the diameter. Use a

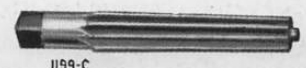


Fig. 46  
A Taper Reamer

collet for gauging, and take a trial cut with the finished reamer and test the hole with a standard plug before the reamer is used.

When setting up, proceed as follows: (See Fig. 47)

1. Adjust the column to zero.
2. Fasten the disc wheel, shape No. 28, to the left hand end of the spindle.
3. Set the dial on the elevating crank to zero, and raise the wheel head from .300" to .400". (About .300" for hard material and .400" for soft material).

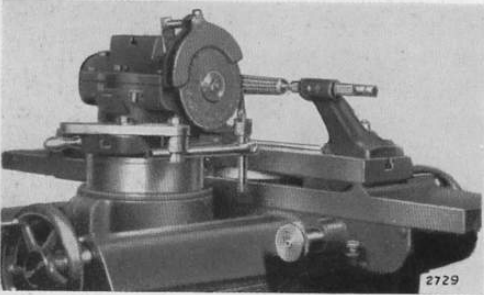


Fig. 47  
Grinding a Taper Reamer

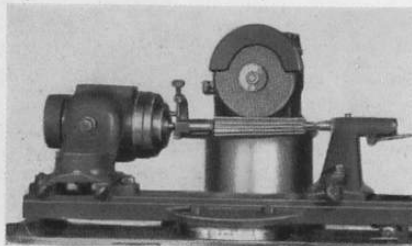


Fig. 48  
Grinding the Faces of the Teeth  
of a Taper Reamer

4. Mount the tooth rest on the emery wheel head with the blade directly in front of the wheel. Place the centreing gauge on the table and adjust the tooth rest blade under the gauge.
5. Adjust the table to the correct taper with the aid of the scale on the right hand end of the slide.
6. Place the reamer between centres, move the saddle towards the wheel and bring one of the reamer teeth against the tooth rest blade.

7. Take a test cut for the correct taper, and then proceed to grind.

If one tooth is ground .0005" higher than the balance of the teeth, a free cutting action with freedom from chatter will be obtained. Of course, this suggestion applies only to finishing reamers.

If the land of the cutting clearance is more than  $\frac{1}{32}$ " wide, the teeth should

be backed off before the cutting clearance is ground.

The cutting edges of a straight tooth taper reamer must be straight to produce good results. Usually, oil-stoning the faces of the teeth is sufficient. However, if they are too irregular to be straightened up in this manner, they may be ground with the dish wheel. Support the reamer between the work-head and tailstock centres, and depress the work head spindle enough to bring the bottom of the flute parallel with the top of the table. (Fig. 48)

## ATTACHMENTS

**Surface Grinding Attachment.** The surface grinding attachment is used for grinding flat forming tools, lathe tools, planer tools, flat thread chasers, drifts, chisels, and work of like nature. The attachment consists of a swivel vice with an intermediate support between the vice and the base, which allows the vice to be swiveled in two planes. (Figs. 49 and 50B) The regular work head support may be removed and placed between the vice support and the base, making the vice adjustable in three planes. (Fig. 50C) It is then possible to completely grind almost any flat tool without removing it from the vice, thereby maintaining greater accuracy between the ground surfaces.

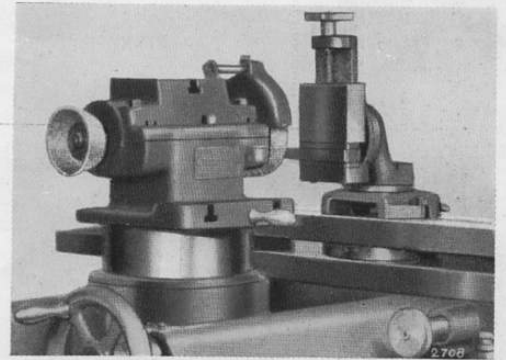
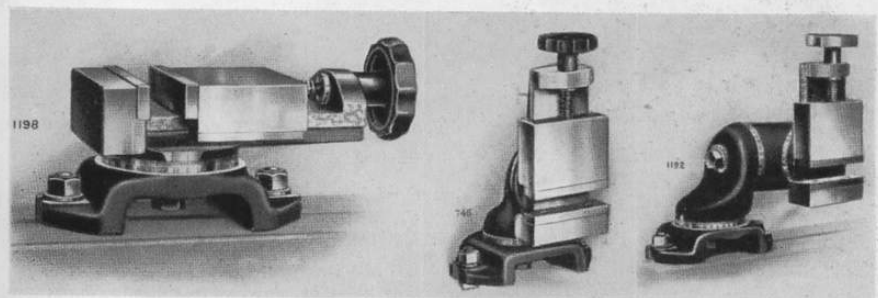


Fig. 49  
Surface Grinding Attachment Set in Vertical Position for Grinding a Lathe Tool

The intermediate support may be removed and the vice body mounted directly on its base (Fig. 50A) which allows a maximum distance of  $6\frac{1}{8}$ " between the centre of the wheel spindle and the top of the vice. With the wheel spindle extension, and the wheel head set at  $90^\circ$ , work up to 4" wide can be ground with this setup. If the work is rigid enough to permit an overhang, the grinding width can be increased to  $5\frac{1}{4}$ ". The vice jaws are 4" wide by  $\frac{15}{16}$ " deep, and open up to  $2\frac{1}{2}$ ".



A

B

C

Fig. 50

## Surface Grinding Attachment

A—Vice in Horizontal Position    B—Vice Set Vertically (Regular Equipment is Shown Here)

C—Complete Universal Arrangement, Obtained by Adding Work Head Bracket

**Cylindrical Grinding Attachment.** The cylindrical grinding attachment can be used for all types of straight or taper cylindrical grinding; such as reamers, lathe centres, mandrels, tap or drill shanks; and for facing operations, such as cutter hubs, gear shaper cutters, collars, nuts, etc. Small machine parts, made in small quantity or experimental lot sizes may also be economically ground with the cylindrical grinding attachment, if dry grinding is permissible.

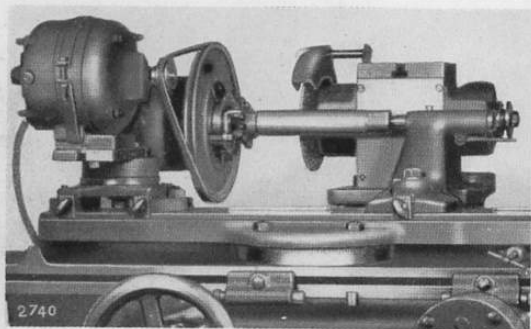


Fig. 51  
Grinding a Steel Mandrel Using the Cylindrical Grinding Attachment

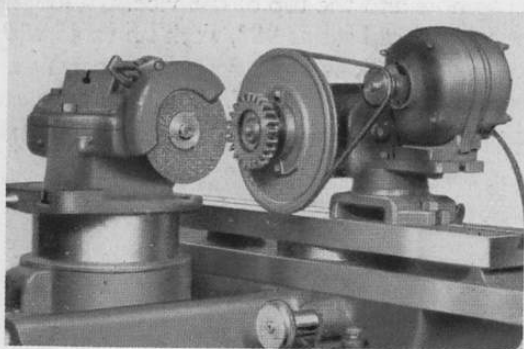


Fig. 52  
Grinding the Face of a Fellows Spur Gear Cutter

This attachment is designed to rotate the work between two dead centres. To set up for cylindrical grinding work which can be held between centres proceed as follows: (Fig. 51).

1. Adjust the column to the zero mark and clamp in place.
2. Fasten the work head to the table, and lock the work head spindle in position with the knurled thumb screw.
3. Place the pulley on the work head dial, and fasten securely with the two screws and clamps provided.
4. Loosen the headless set screw through the work head dial, allowing the pulley and dial to rotate freely on the spindle.
5. Place the work head motor and endless belt in position, and clamp securely.
6. Fasten the driving dog in position on the pulley.
7. Set the table to zero (as shown by the scale on the end) or to the desired taper.

When grinding the sides of thin cutters, saws, washers, etc., it is necessary that the work head spindle and work rotate together, since the chuck which holds the work is driven by the spindle. To accomplish this result, loosen the knurled thumb screw through the work head casting and tighten the headless set screw through the work head dial, which allows the spindle to rotate with the pulley.

Use the front table feed wheel for finishing. For roughing, disengage the front table feed and push the table by hand or use the rear knob control.

The pulley on the work head rotates at 360 r. p. m. if the standard 1750 r. p. m. work head motor is used. Use any desired wheel. If wheel shape No. 25 or No. 24 is used, they should be trued with the truing attachment.

**Internal Grinding Attachment.** This attachment is ordinarily used for grinding holes in cutters, jig bushings, arbor collars, etc. To set up, proceed as follows:

1. Remove both wheel guards and grinding wheels.
2. Fasten the driving pulley on the left hand end of the wheel spindle.
3. Place the attachment on top of the wheel head, place the belt over the two pulleys, and bolt the attachment in place. See that the belt is tight.
4. Adjust the column to zero.

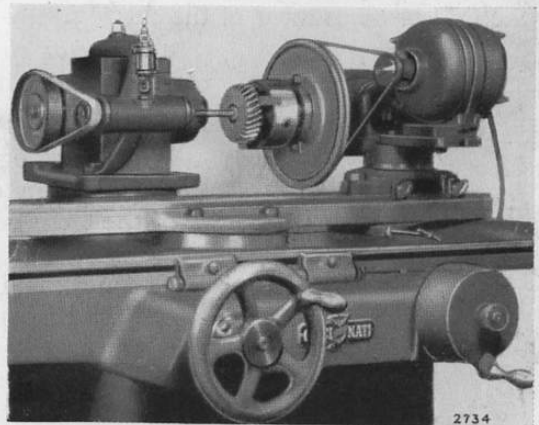
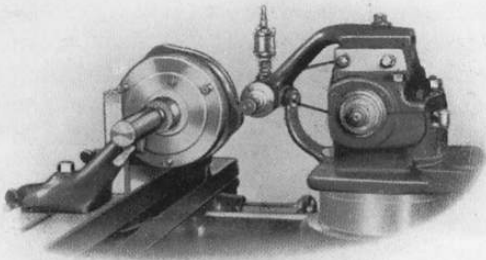


Fig. 53  
Internal and Cylindrical Grinding Attachments.  
Grinding the Hole in a Gear

The spindle runs at 13,150 r. p. m. with the machine driving belt on the small step of the pulley, and 19,590 r. p. m. with the belt on the large step. We recommend that the high speed be used, to get the surface speed of the wheel as near as possible to the proper figure. For roughing, use the rear knob control. For finishing, use the front table feed control, and set the table dogs. Holes  $\frac{9}{16}$ " diameter by 3" long can be ground with this attachment.





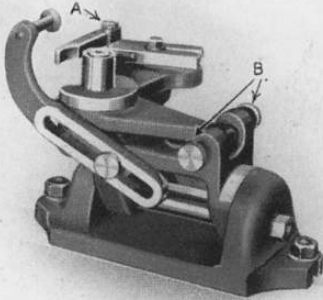
PC-187

Fig. 54  
Grinding a Cam with the Internal  
Grinding Attachment

An unusual application of the internal grinding attachment to external grinding of master cams is shown in Fig. 54. The cam is clamped to a degree vernier swivel, mounted between the tailstock centres. The swivel is rotated a fraction of a degree and the cross slide is adjusted in or out a corresponding amount, and then the work is moved past the wheel. The accuracy obtained, which depends largely

upon the accuracy of the cross screw in the machine, is well within the limits set for this job.

**Gear Cutter Sharpening Attachment.** Since gear cutters are form relieved, the only correct way they can be sharpened is to grind the *faces* of the teeth. (Figs. 56 and 57). To accomplish this result, it is necessary that the feed or adjustment of the cutter to the grinding wheel should be a *rotary or circular adjustment*, as provided for in the Cincinnati Gear Cutter Sharpening Attachment.



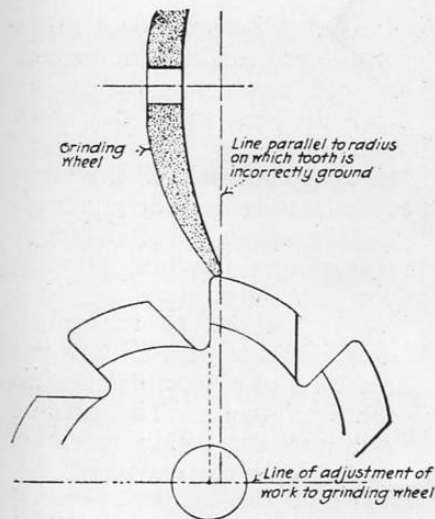
PC-173

Fig. 55  
Gear Cutter Sharpening Attachment

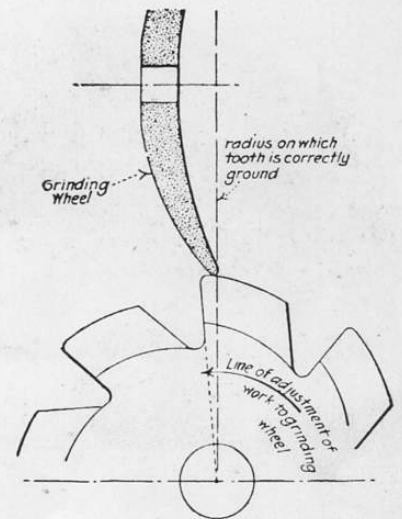
When grinding a new cutter for the first time, it is necessary to grind the *backs* of the teeth before grinding the cutting edge. This extra operation need only be done once, but it is necessary because the pawl locates from the back of the teeth, and if they are all ground uniformly, more accurate results can be obtained.

To set up for the first grinding of an ordinary gear cutter, proceed as follows: (See Fig. 58)

1. Fasten the extension on the left end of the wheel spindle.
2. Place wheel shape No. 21 in position.
3. Set the wheel head to 90° and clamp in place.
4. Clamp the attachment on the table, to the left of the wheel, with the pawl side *away* from the wheel. See that the upper swiveling part of the attachment is set to zero on the degree readings.

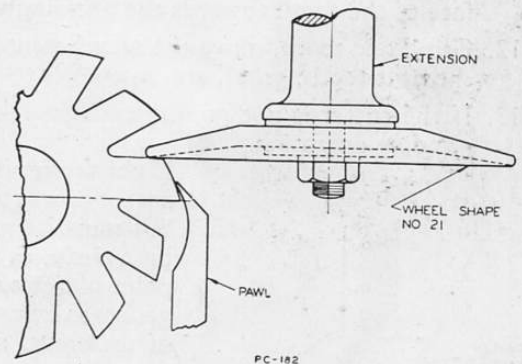


**Fig. 56**  
The Wrong Way to Grind a Radial Tooth Gear Cutter. The face of the tooth is ground in a plane parallel to the radius, deforming the tooth profile



**Fig. 57**  
The Correct Way to Grind a Radial Tooth Gear Cutter. The face of the Tooth is ground in a Radial Plane

5. Place the cutter on the stud in the reverse position, so that the back of the tooth can be ground.
6. Set the centring gauge on top of the wheel head and adjust the head vertically until the cutter and gauge are about central. Remove the gauge and adjust the saddle in or out, and at the same time rotate the cutter by hand on the stud to bring the back of the tooth in the same plane with the face of the wheel.
7. Place the edge of the pawl on the outside diameter of the tooth being ground, and clamp in place by tightening screw "A". (Fig. 55).



**Fig. 58**  
Grinding the Backs of the Teeth of a New Gear Cutter

8. To index for grinding the back of the next tooth, move the cutter away from the wheel and lift the cutter off the stud by hand. Hold the cutter lightly against the solid pawl with one hand while grinding.

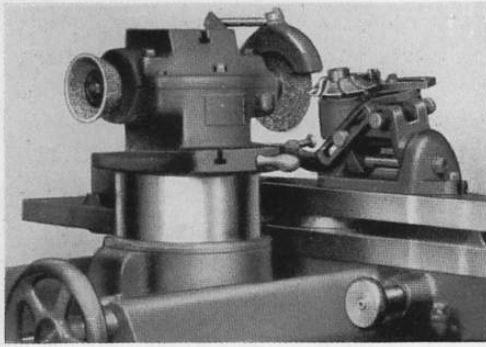


Fig. 59  
Grinding the Faces of the Teeth on a  
Stagger Tooth Gear Cutter

Due to deformations set up in hardening, the amount ground off one tooth may be greater than the next tooth, but there will then be a uniformity between the back of the teeth (the locating side for grinding) and the outside diameter. Notice that during the first grinding operation the pawl is fixed, whilst for the second or sharpening operation, the pawl swivels and acts as a stop when indexing to the next tooth. To continue with the sharpening operation (radial tooth cutters only):

9. Swivel the centring gauge up to the top of the attachment, rotate the cutter by hand on the stud to bring the face of one tooth against the gauge, loosen thumb nut "A" and clamp the pawl against the back of the tooth, and then swing the gauge out of the way.
10. Adjust the saddle to bring the face of a tooth in line with the face of the grinding wheel. Do not re-adjust the saddle whilst the cutter is being ground, except to compensate for wheel wear.
11. Loosen one thumb screw "B" and tighten the other one to rotate the face of the tooth towards the grinding wheel.
12. Grind one tooth, move the attachment away from the wheel, index to the next tooth, grind, and so on.
13. If the cutter is not ground enough, re-set screws "B" and repeat the grinding operation.

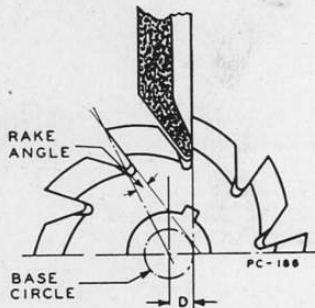


Fig. 60  
Gear Cutter with  
Undercut Teeth

If the teeth are provided with rake or undercut, of course they can not be ground radially, but must be ground in a plane tangent to the base circle, as shown in Fig. 60. Line up the point of one cutter tooth with the attachment gauge, as before, swivel the table to the degree of undercut, adjust the saddle to bring the face of the tooth in line with the face of the wheel, and grind. (Also see discussion on page 14.) If the cutter is not ground enough, adjust the saddle towards the wheel to compensate for wheel wear, and repeat the operation.

Roughing gear cutters are sometimes made with alternate side rake on the teeth to pro-

duce a better cutting action. These stagger tooth cutters can be ground by using the standard gear cutter grinding attachment. When setting up, proceed as for the regular cutter, then tilt the upper part of the attachment the amount of the side rake, which is usually seven to ten degrees. Set the gauge to the outer edge of the tooth and clamp the pawl in position to rest on the back of the tooth. Adjust the saddle until the edge of the wheel just touches the outer edge of the tooth, then proceed to grind every other tooth. For the second operation, tilt the upper part of the attachment the same amount in the opposite direction, touch up the outer edge of the tooth with the wheel, and proceed to grind. (Fig. 59)

The cutter stud on the attachment is  $\frac{7}{8}$ " diameter, but adapter bushings of 1",  $1\frac{1}{4}$ ",  $1\frac{1}{2}$ ",  $1\frac{3}{4}$ ", and 2" outside diameter are supplied for cutters with these hole diameters. (Metric sizes are; stud 22 mm. and bushings 27 mm, 32 mm, 40 mm, and 45 mm O. D.) Gear cutters or any cutter of similar design up to  $8\frac{3}{4}$ " diameter and up to 2" hub thickness can be ground on this attachment.

**Angular Wheel Truing Attachment.** The Angular Wheel Truing Attachment was developed for accurately truing and setting the wheel for grinding spiral hobs, special form cutters and similar tools without the use of a special machine. Since these cutters are form relieved, they must be ground on the face of the teeth, the spiral being obtained from a master guide. The master guide must be of the same number of teeth and the same spiral angle as the cutter. To set up, proceed as follows: (See Fig. 61)

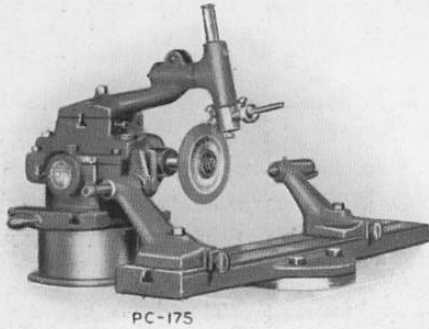


Fig. 61  
Angular Wheel Truing Attachment

1. Place the cutter and guide on an arbor.
2. Clamp the right-hand and left-hand tailstocks to the table, the correct distance apart for the arbor.
3. Place the extension on the end of the spindle, and fasten a 6" diameter wheel about  $\frac{1}{2}$ " wide to the extension.
4. Swivel the wheel head 90 degrees.

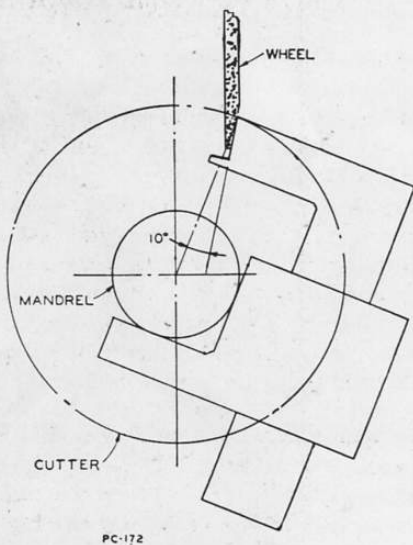
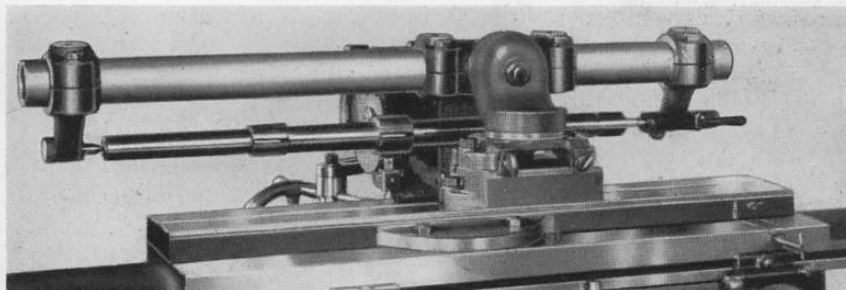


Fig. 62  
Setting the Wheel in the Proper Relation to the Cutter

5. Clamp the truing attachment in place on top of the wheel head, with the finished surface flush with the left hand side of the head.
6. True the wheel, then swing the diamond bar holder out of the way.
7. Swivel the wheel head the amount of the spiral and the same hand.
8. Place the arbor between centres.
9. Measure the outside diameter of the mandrel or arbor collars and adjust the gauge for this diameter, opening it wide enough until the top of the gauge blade is flush with the outside diameter of the cutter, as shown in Fig. 62.

10. Hold the setting gauge against the mandrel with one hand and with the other hand adjust the saddle in or out until the angular end of the gauge blade is flush with the angular face of the wheel, and the wheel is at the proper depth for the cutter tooth. (Fig. 62) *Do not* move the saddle or wheel head during the remainder of the grinding operation.
11. Clamp the micrometer tooth rest on the wheel head, place one tooth of the cutter against the wheel, and rest one tooth of the guide against the tooth rest blade.
12. Adjust the tooth rest blade back a few thousandths, so that the adjustment for grinding is *radial*, thereby maintaining the outline of the cutter teeth. Proceed to grind.

The Angular Wheel Truing attachment is designed for cutters up to 6" diameter.



Extension Centres

**Extension Centres.** This attachment is useful in grinding long lining reamers, boring bars, extension taps, stay-bolt taps, cutters on arbors when concentricity is important, and long work of like nature. The method of grinding the part is not altered due to using this attachment. To avoid excessive overhang, and to prevent tipping of the table and slide, swivel the table 180°. The attachment centres (without the raising blocks) are  $\frac{7}{8}$ " above the level of the table. The maximum cutter diameter which will clear the supporting bracket is 6", but if the cutter is located between the support and the right or left hand tailstock, a 7" diameter cutter will clear. Work up to 34" long can be placed between the attachment centres.

**Blade Grinding Attachment.** This attachment was designed for the purpose of grinding centreless grinder work rest blades. When setting up, the only precaution necessary is to see that the slot for holding the blade and also the bottom of the attachment is clean before clamping the blade in position. Use the flare cup wheel, shape No. 23.

The angle of a centreless grinder blade varies according to the diameter of the work to be ground, the type of work, and the material. Thirty

TOOL ROOM

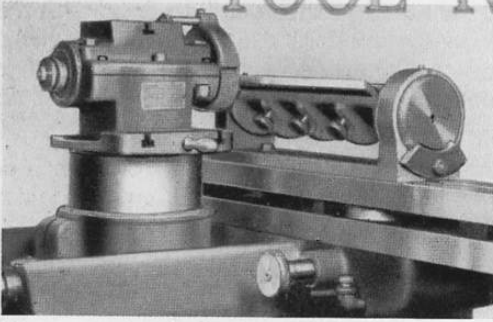


Fig. 64  
Blade Grinding Attachment

degrees has been found to be the best blade angle for general purpose centreless grinding, but for large diameters, the angle may be reduced to as low as 10 degrees. On the other hand, an oil groove or oil hole in the work will cause out-of-roundness, and to correct this fault it is necessary to reduce the wheel pressure by grinding a steeper angle on the blade, in some cases as much as 45 degrees.

**Face Mill Grinding Attachment.** Face mills up to 8" diameter may be ground on the standard work head of the machine without the use of a special attachment. Larger cutters up to 18" diameter, may be ground on the No. 2 Cutter Grinder by using the face mill grinding attachment, which was designed especially for large diameter mills.

To set up this attachment for grinding a face mill with a cup wheel, proceed as follows:

Grinding the Face, Figure 65.

1. Mount the cup wheel, shape No. 23, on the left hand end of the spindle, and fasten the wheel guard in position.
2. Swivel the wheel head 90 degrees, and true the wheel.
3. Loosen the table clamping screws and turn the pin handle in front of the table one-half turn. Swivel the table 180 degrees.
4. Clamp the attachment to the machine table about midway between the ends, the exact location depending upon the size of the cutter.
5. Mount and clamp the face mill on the nose of the attachment (see Figure 66 for suggested methods).

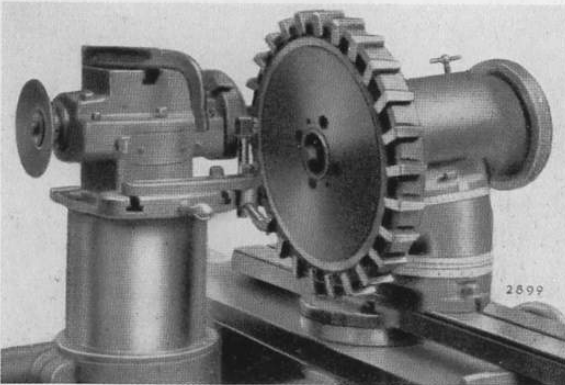
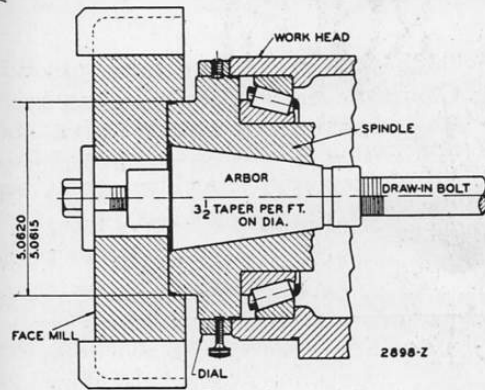
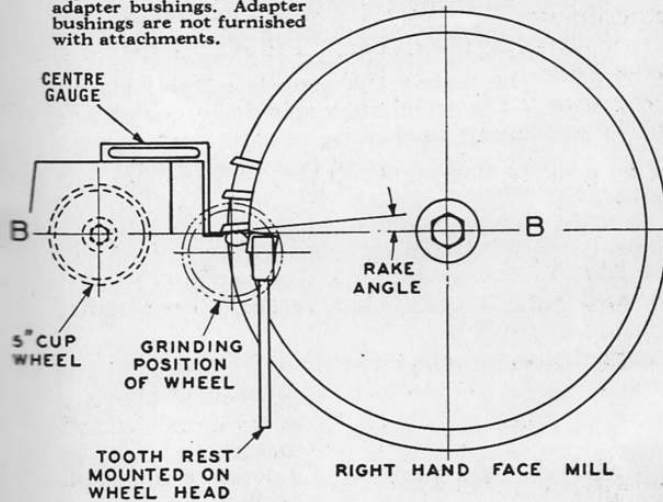


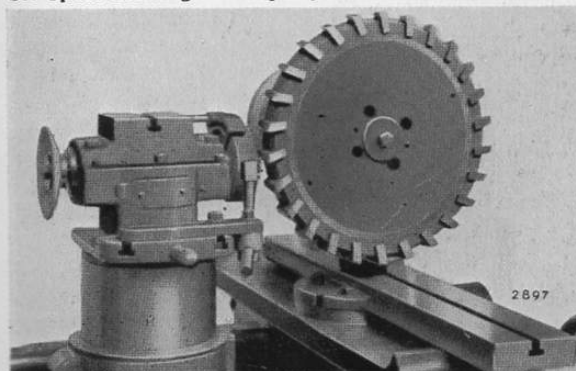
Fig. 65  
Grinding the Face of the Teeth on an 18" Diameter Face Mill



**Fig. 66**  
Face mills fitting the National Standard Milling Machine Spindle Nose centre on the attachment spindle. Other face mills can be centred on the 1 1/2" diameter end of arbor either direct or by adapter bushings. Adapter bushings are not furnished with attachments.



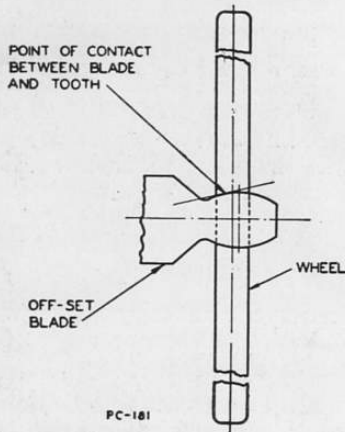
**Fig. 67**  
Set-Up for Grinding the Periphery of the Teeth of Face Mill.



**Fig. 68**  
Grinding the Periphery of the Teeth on an 18" Diameter Face Mill.

6. Swivel the spindle housing to match the 0-line on the upper scale of the intermediate plate, and clamp. Then swivel the housing and plate as a unit to match the 0-line of the lower scale with the base, and clamp. The attachment spindle is now in a horizontal plane, and at right angles to the cutting edge of the wheel.
7. Set the attachment to the desired clearance angle (for example, 7 degrees).
  - a. Loosen the spindle housing bolts, swivel housing 7 degrees to the left, and clamp.
  - b. Loosen the intermediate plate bolts, swivel the housing and plate 7 degrees to the right, and clamp.
8. Place the centring gauge on top of the wheel head. Adjust the wheel head, table, and saddle until the gauge matches the centre of the face mill. (See Figure 67.)
9. Return the table to its original position, rotate the cutter to bring the outside edge of one tooth against the gauge, and lock the spindle in position.
10. Bring the cutter to its approximate grinding position in front of the wheel and adjust the wheel head so that the wheel will clear the



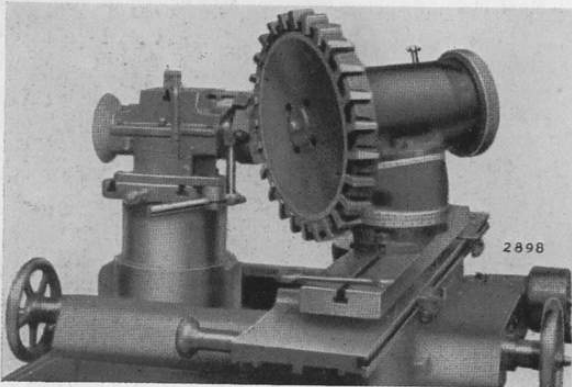


**Fig. 69**  
Point of Contact Between  
Blade and Tooth in  
Relation to High  
Point of Wheel

11. Clamp the tooth rest on the wheel head and adjust it to suit, bringing the finger up under the tooth to be ground.
12. Loosen the spindle locking screw, set the dogs in front of the table, and grind.

**Grinding the Periphery (Figures 67 and 68)**

13. The tooth rest setting remains the same as before, with the exception of slight adjustments to bring the high point of the finger to the correct position.
14. Swivel the spindle housing to match the zero line on the upper scale of the intermediate plate, and clamp. Then swivel the housing and plate as a unit to match the zero lines, and clamp. The attachment spindle is now set in a horizontal plane at right angles to the cutting edge of the wheel.
15. Place the centring gauge on top of the wheel head. Adjust the column and saddle to bring the centre of the cutter in line with the point of the gauge. Now turn the spindle to bring the outside edge of one tooth against the point of the gauge. Lock the spindle in this position. Radial line B-B (Figure 67) is now parallel to the top of the table.
16. Loosen the bolts through the intermediate plate and swivel the housing and plate as a unit, matching the 0-mark with the 90 degrees mark.
17. Now set the clearance setting dial on the spindle of the attachment to 0-mark.



**Fig. 70**  
Grinding the Corners of the Teeth of  
18" Diameter Face Mill

- Loosen the spindle locking screw and turn the spindle until the dial indicates the desired clearance angle, and again lock in place.
18. Now bring the cutter tooth close to the wheel and adjust the wheel head until the tooth rest blade touches the cutter tooth.
19. Loosen the spindle locking screw and grind

Grinding the Corners, Figure 70.

20. The tooth rest setting and the general procedure is the same as outlined above.
21. Loosen the bolts through intermediate plate and swivel the housing and plate 45 degrees, using, in this case, 7 degrees on the lower scale of the plate as a starting point.
22. Loosen the bolts through spindle housing and swivel it 7 degrees to the left. Re-set and grind, similar to the previous operations.

**Radius Grinding Attachment.** This attachment was designed primarily for grinding a true radius on face mills or any similar cutter which is ordinarily ground to an approximate radius by a 45° flat or a series of flats. The time between grindings of the cutter is appreciably increased by the use of the radius grinding attachment, because the sharp corners, which are the starting point for a rapidly wearing cutting edge, are completely eliminated. The various steps necessary in setting up the attachment for

grinding a face mill by the disc wheel method are listed below. Notice that the face, radius, and periphery of the cutter can all be ground at one setting. Cutters from 4" to 12" diameter, and with a maximum width of face of 3", may be ground on this attachment to a maximum radius of 1"

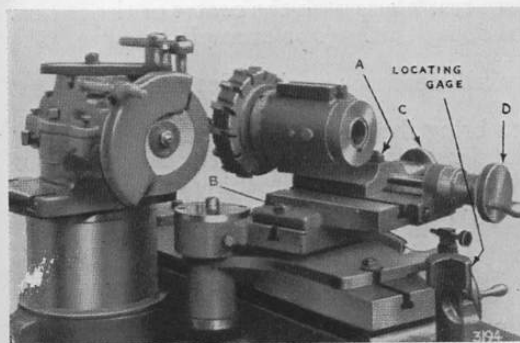


Fig. 71  
Radius Grinding Attachment

1. Clamp the attachment to the left-hand end of the table, and clamp the stop bracket to the table, about 1½" from the right hand edge of the attachment casting.
2. Attach the extension to the left-hand end of the spindle, mount wheel shape No. 27 to the extension, fasten the wheel guard in position, and set the wheel head at zero. If a 2" extension is available, it should be used, because a much more rigid tooth rest set-up can be obtained.
3. Fasten the standard workhead housing to the attachment, with its spindle in the horizontal (zero) position. The T-slot nearest the grinding wheel is for small diameter cutters, while the other T-slot is for large cutters.
4. Mount the tooth rest holder in place:
  - a. On the wheel head for spiral teeth.
  - b. On the work head for radial teeth.

5. Mount the cutter on a suitable stud in the work head, and adjust both slides their maximum distance away from the setting gauge stud.
6. Place the setting gauge on the stud. Then loosen four nuts "A" and "B" and adjust the two slides until the periphery and face of one cutter tooth match the locating surfaces of the gauge. There are various ways of obtaining this setting, each man usually preferring his own method. The attachment is now set for a zero radius.
7. Remove the gauge. Set the dials at zero, being certain that the "back lash" is eliminated. Adjust the two slides the same amount, equal to the radius desired, beyond the setting gauge location.

The instructions for the remainder of the set-up are very similar to any face or shell end mill sharpening job. However, if you are not familiar with the operation, proceed in the following manner.

8. Shape the wheel slightly convex. (See Fig. 69)
9. Set the tooth rest blade in position as illustrated in Fig. 69, using the offset blade.
10. Align the high point of the tooth rest blade with the centre of the cutter. There are several methods of doing this. (For example, see Fig. 67.)
11. Lower the wheel head the desired clearance angle. See table, page 62.
12. Now swivel the attachment to bring the outside diameter of the cutter parallel to the wheel spindle. Adjust dial "D" to clear the desired radius setting, but *do not* move dial "C" during the sharpening operation.
13. Adjust the machine cross screw to bring the cutter to within about .001" of the wheel. Move the table slide to bring the pivot point of the attachment central with the wheel. Set the dogs on the table slide and clamp.
14. Grind the radius by swiveling the cutter through 90°. For feeds, adjust dial "D", but do not feed past the dial setting established in step No. 7.

### ADJUSTMENTS FOR WEAR

**Adjusting the Headstock Spindle Bearings.** There should be no occasion to adjust these bearings very often, but in case it becomes necessary, nut "B" provides the adjustment. (Fig. 73)

1. Loosen screw "A" (Fig. 73) in lock nut "B".
2. Tap the lock-nut to loosen the lock shoe.
3. Hold the spindle with one hand and turn nut "B" with the other, until there is no evidence of looseness.
4. Re-tighten screw "A".

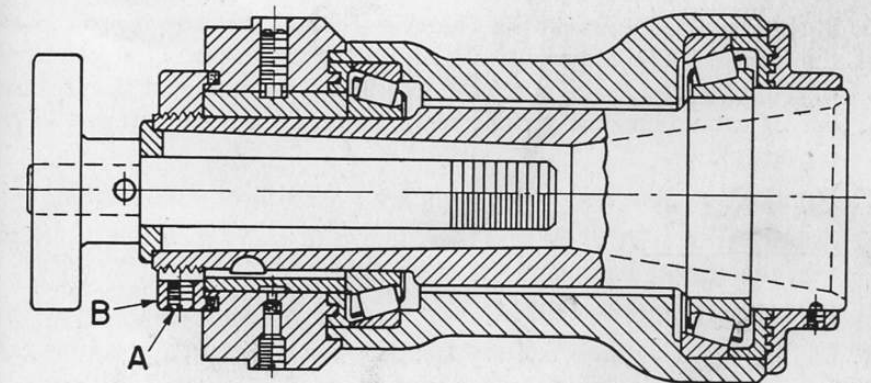


Fig. 75. Section Through Headstock Spindle

**Replacing the Grinding Wheel Spindle Bearings.** If the wheel spindle bearings should become worn or damaged in any way, do not try to replace them with standard commercial bearings. The spindle is equipped with precision preloaded ball bearings, made especially for this particular application, and fitted by thoroughly experienced assemblers. We strongly recommend that you remove the spindle unit (instructions listed under "Replacing the Main Driving Belt"), and send it to us when it is in need of repairs.

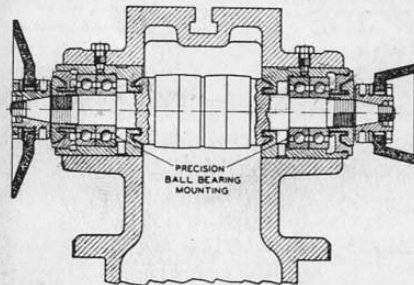
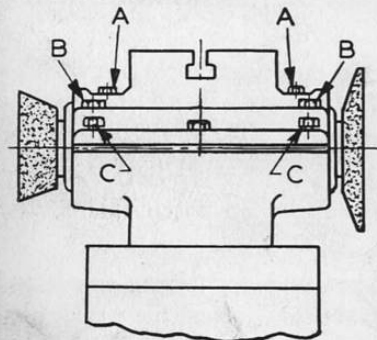


Fig. 74  
Section Through Grinding  
Wheel Spindle

**Replacing the Main Driving Belt.** If the belt from the motor pulley to the wheel head becomes broken or worn, it may be replaced as follows:



PC-192  
Fig. 75  
Rear View of Grinding Wheel Head

1. Remove the wheel guards and wheels.
2. Remove the instruction plate held to the front of the wheel head by four screws.
3. Remove two screws "A".
4. Loosen clamping screws "B" (Fig. 75) in the wheel head, and tighten spreader screws "C".
5. Take the worn belt off the motor pulley.

6. Push the spindle through the wheel head a sufficient amount to slip off the worn belt and to hook on the new belt through the opening in front of the wheel head. (The spindle, bearings, lock nuts, and sleeve come out as a unit making it unnecessary to make any adjustment when replacing).
7. Replace the spindle.
8. Replace screws "A". Be sure these screws fit easily their full depth, so that the bearing retainers will not be sprung.
9. Release spreader screws "C".
10. Lightly tighten clamp screws "B". Do not tighten these screws too much, or the spindle unit may be sprung.

**Tightening the Belt.** The procedure for tightening the belt is the same as outlined for shifting the belt from one pulley to another (page 8).

### GRINDING CEMENTED CARBIDE TIPPED BLADE MILLING CUTTERS

The correct grinding of Cemented Carbide Face Milling Cutters is very essential in order to obtain the best results—longer cutter life and economical metal removal. The following points should be considered when using cemented carbide tipped blade milling cutters:

1. In general, milling cutters should be made with inserted blades so that in case of damage to any one blade it can be removed and repaired without disturbing the other blades.
2. The body should be especially designed for use with cemented carbide blades, and should have a strong backing as near as possible to the cutting edge. Correct cutting angles should be obtained by proper placing of the cutter blades with respect to the cutter body, rather than attempting to grind the angle on the blade itself.
3. Experience tells us that it is best to regrind dull cutters when it shall be necessary to remove only .005" to .008" from each blade in order to restore the keen cutting edges.
4. When milling cutters are first tipped with new blades, it is best that they be ground first to the approximate size and then assembled in the cutter body.
5. If one blade extends beyond the other blades when they are assembled preparatory to grinding, time will be saved and wheel life prolonged, by removing the high blade and grinding it independently on an off-hand grinder until it has been reduced to approximately the same size as the remaining blades.

6. Two operations, rough and finish grinding, are required to obtain a good commercial finish on the work. If a mirror finish is required, the cutter teeth must be lapped. However, this operation requires considerable time, and the results obtained have little advantage over the commercial finish.
7. The amount removed by the finish operation is only about .0002". The main purpose of this operation is to smooth the cutting edge.
8. Always grind toward the cutting edge. Feed the grinding wheel only when the rotation of the wheel and movement of the table are towards the cutting edge.
9. Use the dry method of grinding. In any event do not mix wet and dry grinding. Intermittent cooling causes strains and cracks in the blades.
10. Use light wheel feeds and soft wheels when grinding the harder grades of the cemented carbide.
11. The maximum difference between the highest and lowest blade, after the sharpening operation is completed, should not exceed .0005".
12. Select one man and train him to grind your cemented carbide milling cutters.
13. Make sure the grinding machine is in good working condition—that it is functioning as it should.
14. Use the recommended clearance angles given below and on page 57 for the different operations.

**Method when using Regular Headstock for Grinding 8" Diameter Cemented Carbide Tipped Blade Face Mill**

**General Set-up Facts.** An 8" diameter right hand face milling cutter with the periphery of teeth shaped to form an angle of 11° with the centre-line of cutter, will serve as a good example to illustrate the method to be followed when using the standard headstock. These set-up facts should be kept in mind:

- (a) Recommended clearance angles:

	Face	Corner	Periphery	Secondary Face	Secondary Periphery
Cast Iron.....	3°	4°	4°	6°	8°
Aluminum.....	4°	8°	8°	8°	12°

- (b) For rough grinding, use a 5" diameter green grit, shape No. 24, grain 60, grade S, bond WGH Carborundum cup grinding wheel or any other suitable make having these characteristics.
- (c) For finish grinding, use the same size and shape of wheel, grain 120, grade U, bond WIG.
- (d) For lapping, use a diamond lapping wheel (180 grain) or Carborundum diamond wheel.
- (e) Mount the above wheel on the right end of grinding wheel spindle so that it will run in a clockwise direction, when looking at the face of the wheel.

- (f) The grinding wheel should rotate toward the cutting edge of the tooth being ground to avoid getting a ragged edge.
- (g) The grinding wheel head is swiveled to  $90^\circ$ .
- (h) A ten-thousandths  $\left(\frac{1}{10,000}\right)$  indicator gauge is mounted on the ledge of the grinding wheel head with its contact stem about level with the wheel spindle and projecting about  $\frac{1}{32}$ " over the face of the grinding wheel. (Indicator is not furnished as standard equipment with No. 2 Cutter Grinder).
- (i) The headstock is mounted upon a 2" raising block (not standard equipment but supplied on request at extra cost) bolted to the machine table.
- (j) The milling cutter to be ground is mounted on a suitable arbor which fits into the headstock spindle. One end of the spindle has a No. 12 B. & S. taper hole, while the other end has a National Standard Taper hole ( $3\frac{1}{2}$ " per foot).

### Grinding Face of the Teeth, Figure 76.

1. Set table on 0-mark.
2. Swivel headstock "A" in a horizontal plane and set approximately to  $90^\circ$ . When the cutter is traversed past the dial indicator, "B" the reading should be zero (0) on the tooth to be ground and  $+.002$ " on the opposite tooth. For smaller or larger cutters this amount may vary slightly.
3. Swing indicator out of way (about  $\frac{1}{2}$ ").
4. Swivel the headstock the desired clearance angle.
5. Level tooth to be ground by using centreing gauge "C" located on top of grinding wheel head and adjust wheel head vertically the desired amount.
6. Mount tooth rest "D" in lower T-slot of headstock and adjust so that blade is brought up under tooth to be ground.
7. Lock headstock spindle.
8. Mount diamond holder (not supplied as standard equipment but can be secured on demand at extra cost) in upper T-slot of headstock.



Fig. 76

Grinding the Face of the Teeth on an 8" Diameter Tungsten Carbide Face Mill

## GRINDING TUNGSTEN CARBIDE FACE MILLS

Adjust diamond to be about  $\frac{1}{64}$ " ahead of and horizontally about 1" away from tooth to be ground and vertically to line up with centreing gauge on wheel head.

9. Swing centreing gauge out of way and true grinding wheel.
10. Withdraw diamond about  $\frac{1}{32}$ " by using independent adjustment "F" on holder.
11. Bring cutter tooth in contact with grinding wheel and grind off about .005" or whatever amount is necessary to get a sharp cutting edge. (Do not remove more than .002" per pass.)
12. Move the table to bring diamond in line with wheel and adjust diamond using independent adjustment on its holder, until it comes in contact with wheel. The diamond is now flush with ground tooth and this setting is to be used as a gauge for all other teeth, and therefore the diamond holder should not be adjusted until all teeth are ground.
13. Set cross feed screw dial on zero (0), then move diamond away from wheel about  $\frac{1}{32}$ " by using cross feed screw rear control wheel.
14. Unlock headstock spindle and index cutter for grinding next tooth.
15. Lock headstock spindle and bring second tooth into grinding position. Grind until cross feed dial registers zero (0), then try diamond. If diamond does not touch wheel (due to wheel wear) grind off slightly more on second tooth until diamond just touches the wheel.
16. Reset cross feed dial to zero (0) and move cutter away from wheel about  $\frac{1}{32}$ ".
17. Unlock headstock spindle, index for next tooth, lock spindle and repeat grinding as described for second tooth.
18. After all the teeth are ground, swing indicator into position and take a reading on each tooth. The readings should not vary more than .0003", if the grinding has been done carefully. The high teeth should be re-ground, if the readings show more than .0005" variation.

### Grinding Corners, Figure 77.

1. Swing diamond holder "C" and tooth rest out of way
2. Move cutter away from wheel by turning cross feed hand wheel.
3. Swivel table to 45°
4. Bring headstock spindle in a horizontal position by setting vertical swivel on zero (0).



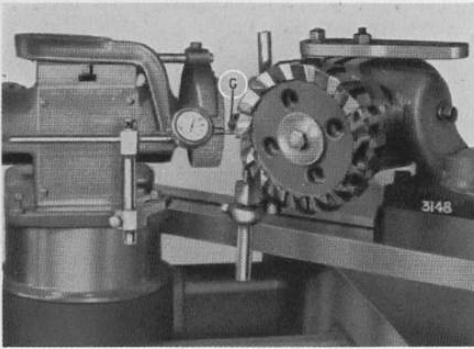


Fig. 77

**Grinding the Corners of the Teeth on an 8\"/>**

5. Adjust wheel head until line on column is 2" above housing (this is done on account of using 2" raising block under headstock).
6. Set edge of tooth even with centreing gauge located on wheel head and lock clearance setting dial on headstock spindle in the zero (0) position.
7. Swing centreing gauge out of way and rotate cutter until clearance setting dial registers the clearance angle desired, then lock headstock spindle.
8. Bring tooth rest into position and set finger under tooth to be ground.
9. Swivel headstock the clearance angle desired.
10. Adjust wheel head until edge of tooth lines up with centreing gauge.
11. Bring diamond holder into position, adjust diamond so it will be about  $\frac{1}{64}$ " ahead of edge of tooth and level with centreing gauge.
12. Proceed as described under items 9 to 18 for grinding the face of teeth.

**Grinding Periphery of the Teeth, Figure 78.**

1. Swivel table to 11° since teeth on this particular cutter have 11° angle on periphery. (On cutters having the periphery teeth parallel with axis, the table is set on zero (0).)
2. Remove diamond holder, since it cannot be used on this set-up on account of interference with wheel.
3. Unlock headstock spindle and swing tooth rest out of way.
4. Swivel headstock in horizontal plane and set on zero (0), also in vertical plane to zero (0).

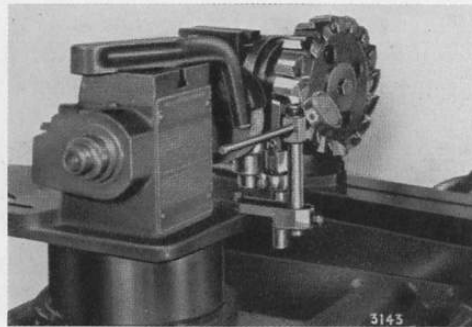


Fig. 78

**Grinding the Periphery of the Teeth on an 8\"/>**

## GRINDING TUNGSTEN CARBIDE FACE MILLS

5. Adjust grinding wheel head until line on column is 2" above housing (due to using 2" raising block under head stock).
6. Set tooth to be ground even with centreing gauge.
7. Lock clearance setting dial on zero (0) and move the centreing gauge out of way.
8. Rotate cutter until clearance setting dial registers the clearance angle desired and lock spindle.
9. Adjust tooth rest and bring finger in contact with tooth to be ground.
10. Adjust grinding wheel head to required position.
11. Bring tooth to be ground in contact with grinding wheel.
12. Set cross feed dial to zero (0).
13. Start grinding and gradually feed in by adjusting cross feed screw until a sharp cutting edge is obtained, then observe cross feed dial reading.
14. Back cutter away from wheel about  $\frac{1}{32}$ ".
15. Unlock headstock spindle, index for the next tooth and lock headstock spindle again.
16. Bring tooth in contact with wheel and reset cross feed dial to zero (0).
17. Feed in on cross feed screw the same amount as observed under item 13.
18. Repeat items 14, 15, 16 and 17 until all teeth are ground.
19. Swing dial indicator into position and check all teeth. Regrind the high teeth if there should be a variation of more than .001" in the readings.

### Method when using Face Mill Grinding Attachment for Grinding 16" Diameter Cemented Carbide Tipped Blade Face Mill

**General Set-up Data.** A 16" diameter right hand face milling cutter will serve as a good example to use in illustrating the method to be followed when using the face mill grinding attachment. These set-up data should be kept in mind:

(a) Recommended clearance angles:

	Face	Corner	Periphery	Secondary Face	Secondary Periphery
Cast Iron.....	3°	4°	4°	6°	8°
Aluminum.....	4°	8°	8°	8°	12°

(b) Use 5" x 1½" x 1¼" green grit, shape No. 24, grain 60, grade "S", bond WGH, Carborundum cup wheel or any other suitable make having the same characteristics.

- (c) Mount the above wheel on the right end of grinding wheel spindle so that it will run in a clockwise direction, when looking at the face of the wheel.
- (d) The grinding wheel should rotate toward the cutting edge of the tooth being ground to avoid getting a ragged edge.
- (e) The grinding wheel head is swiveled to 90°.
- (f) A ten-thousandths ( $\frac{1}{10,000}$ ) indicator is mounted on the ledge of the grinding wheel head with its contact stem about level with the wheel spindle and projecting about  $\frac{1}{32}$ " over the face of the wheel. (Indicator is not furnished as standard equipment with No. 2 Cutter Grinder, but is supplied on demand, at extra cost).

**Grinding the Face of the Teeth, Figure 79.**

1. Loosen the table clamping screws and turn the pin handle in front of table one-half turn. Swivel the table 180°.
2. Clamp the face mill grinding attachment to the machine table about midway between the ends, the exact location depending upon the size of the cutter to be ground.

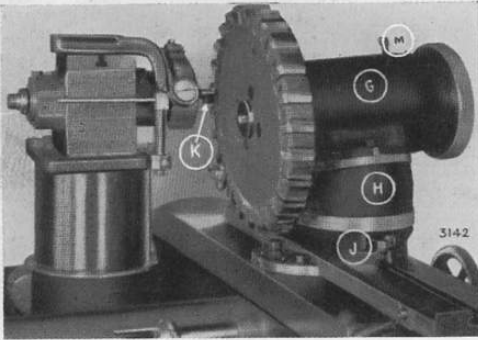


Fig. 79  
Grinding the Face of the Teeth on a 16" Diameter Tungsten Carbide Face Mill

3. Mount and clamp the face mill on the nose of the attachment (see Fig. 66 for suggested method).
4. Swivel the attachment spindle housing "G" to match the 0-line on the upper scale of the intermediate plate "H" and clamp. Then swivel the housing and plate as a unit to match the 0-line of the lower scale with the 0-line on the base "J" and clamp. The attachment

spindle is now in a horizontal plane and at right angle to the cutting edge of the wheel.

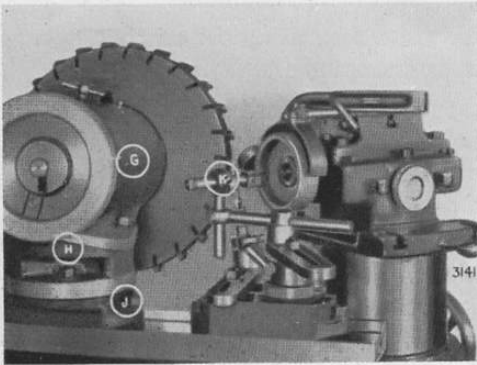
5. Set the attachment to the desired clearance angle, for example 3°.
  - a. Loosen the bolts through spindle housing "G", swivel it 3 degrees to the left and clamp.

## GRINDING TUNGSTEN CARBIDE FACE MILLS

- b. Loosen the bolts through intermediate plate "H" swivel the housing and plate 3 degrees to the right and clamp.
6. Adjust the grinding wheel head, table and saddle until the dial indicator on wheel head comes in contact with one of the teeth. Rotate the face mill slowly and note the dial reading of each tooth. Mark the lowest tooth as the first one to be ground, then swing the indicator out of way.
7. Level or line up the tooth to be ground by using the centreing gauge on wheel head and lock the attachment spindle.
8. Clamp a 2" raising block (not supplied as standard equipment, but can be obtained at extra cost) on table and mount the tooth rest on it with the finger brought up under the tooth to be ground.
9. Mount a diamond holder "K" (not supplied as standard equipment, but can be obtained at extra cost) on the raising block and bring it as close to the tooth rest as possible. Adjust the diamond so that it will be about  $\frac{1}{64}$ " ahead of and about level with the tooth to be ground.
10. True the wheel and withdraw the diamond about  $\frac{1}{32}$ " by using the independent adjustment on its holder.
11. Bring the cutter tooth in contact with the grinding wheel and grind off about .005" or the required amount that is necessary to get a sharp cutting edge.
12. Move the table so as to bring the diamond in line with the wheel and adjust the diamond by means of its independent adjustment until it comes in contact with the wheel. The diamond is now flush with the ground tooth and this setting is to be used as a gauge for all other teeth. Therefore the diamond holder should not be adjusted until all the teeth are ground.
13. Set the cross feed screw dial on zero (0) then move the diamond away from the wheel about  $\frac{1}{32}$ " by using the cross feed screw control.
14. Unlock the attachment spindle and index for grinding the next tooth.
15. Lock the attachment spindle and bring the tooth into grinding position. Grind this tooth until the cross feed screw dial registers zero (0). Then try the diamond, if it does not touch the wheel (due to wheel wear) grind slightly more off the tooth, until the diamond just touches the wheel.
16. Reset the cross feed dial to zero (0) and move the cutter away from the wheel about  $\frac{1}{32}$ ".
17. Repeat items 14, 15 and 16 until all the teeth are ground.
18. Swing the dial indicator into position, unlock the attachment spindle and take a reading on each tooth. The dial indicator readings should not vary more than .0003", if the grinding has been done carefully. The high teeth should be reground if the variation is more than .0005".

**Grinding the Corners, Figure 80.**

1. Adjust the saddle and move face mill away from the wheel about 1".
2. Swing the diamond holder "K" and tooth rest out of the way.



**Fig. 80**  
**Grinding the Corners of the Teeth on a 16"**  
**Diameter Tungsten Carbide Face Mill**

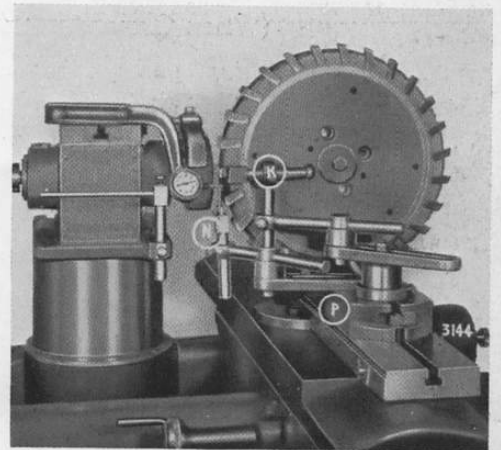
3. Set the attachment to the desired clearance angle (for example 4°).
  - a. Loosen the bolts through spindle housing "G", swivel it to the left to match the 4 degree line on the upper scale of the intermediate plate "H" and clamp.
  - b. Loosen the bolts through intermediate plate "H", swivel the housing and plate to the right to match the 4 degree line on the lower scale with the 0-line on the base "J" and then clamp in position.
4. Place the centreing gauge on top of the wheel head. Adjust the column and saddle to bring the centre of the cutter in line with the point of the centreing gauge. Loosen the attachment spindle locking screw, move the table and turn the spindle to bring the outside edge of one tooth against the point of the gauge. Set the clearance setting dial on the spindle of the attachment to 0-mark and swing the gauge out of the way. Turn the spindle until the dial indicates the desired clearance (4°), then lock spindle.
5. Adjust the saddle, loosen the table bolts, swivel the table to 45 degrees and clamp.
6. Bring the tooth rest into position and adjust the finger under the tooth to be ground.
7. Clamp the diamond holder "K" in position close to the tooth rest. Adjust the diamond about  $\frac{1}{64}$ " ahead of and about level with the tooth to be ground.
8. Continue the procedure as described for grinding the face teeth, items 10 to 18.

**Grinding the Periphery of the Teeth, Figure 81.**

This set-up is mentioned last, because it has been found that it is not always necessary to grind the periphery of the teeth when the face of teeth and corners require sharpening.

1. Remove the tooth rest "N", diamond holder "K" and raising block "P" and place raising block on opposite end of table.
2. Loosen the table bolts, swivel the table to the zero position and clamp.

3. Loosen the bolts through attachment spindle housing and swivel the housing to match the zero (0) line on the upper scale of the attachment intermediate plate, and then clamp. Loosen the bolts through intermediate plate, swivel the housing and plate as a unit to match the zero (0) line of the lower scale with zero (0) line on the base and then clamp.



**Fig. 81**  
**Grinding the Periphery of the Teeth on a**  
**16" Diameter Tungsten Carbide Face Mill**

4. Place the centreing gauge on top of wheel head and adjust the wheel head, table and saddle until the centre of the cutter lines up with the point of the centreing gauge. Move the table and rotate the spindle until the outer edge of one tooth is in line with centreing gauge. Lock the spindle and swing the centreing gauge out of the way.
5. Adjust the saddle the required amount and set the attachment to the desired clearance angle (for example, 4°).
  - a. Loosen the bolts through spindle housing and swivel it to the left to match the 4 degree line on the upper scale of the intermediate plate and clamp.
  - b. Loosen the bolts through intermediate plate, swivel the housing and plate to the right to match the 4 degree line on the lower scale with 90 degree line on the base and clamp. The periphery of the tooth to be ground is now parallel with the table and set for 4° clearance.
6. Mount the tooth rest "N" on the raising block "P" with the blade brought up under the tooth to be ground.

7. Mount the diamond holder "K" on the raising block and bring it as close to the tooth rest as possible. Adjust the diamond so that it will be  $\frac{1}{64}$ " ahead of and practically level with the tooth to be ground.
8. The procedure as described for grinding the face of the teeth, under items 10 to 18 should now be followed.

**CLEARANCE ANGLES FOR FACE MILLS**  
(When Ground with a Disc Wheel)

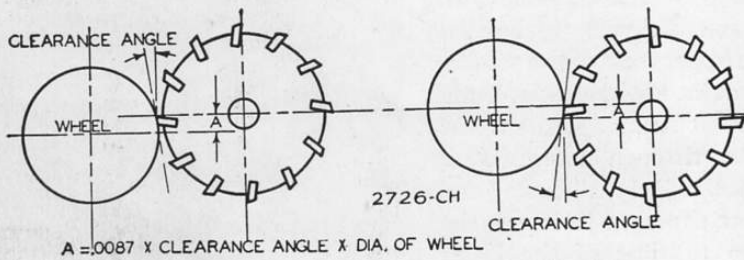


Fig. 82  
Left Hand Face Mill

Fig. 83  
Right Hand Face Mill

Wheel Dia.	CLEARANCE ANGLE									
	1°	2°	3°	4°	5°	6°	7°	8°	9°	10°
	DISTANCE A IN INCHES									
3	.026	.052	.078	.104	.130	.156	.182	.208	.235	.261
3 1/4	.028	.056	.084	.113	.141	.169	.198	.226	.254	.283
3 1/2	.030	.061	.091	.122	.152	.182	.213	.243	.274	.304
3 3/4	.032	.065	.097	.131	.163	.195	.228	.261	.293	.326
4	.034	.069	.104	.139	.174	.208	.243	.278	.313	.348
4 1/4	.037	.074	.111	.148	.185	.222	.258	.295	.333	.370
4 1/2	.039	.078	.117	.156	.196	.235	.273	.312	.352	.391
4 3/4	.041	.082	.124	.165	.206	.248	.288	.330	.372	.413
5	.043	.087	.130	.174	.217	.261	.304	.347	.391	.435
5 1/4	.045	.091	.137	.183	.228	.274	.319	.365	.411	.457
5 1/2	.047	.095	.144	.191	.239	.287	.335	.382	.430	.478
5 3/4	.050	.100	.150	.200	.250	.300	.350	.400	.450	.500
6	.052	.104	.156	.208	.261	.313	.365	.417	.470	.521
6 1/4	.054	.109	.163	.217	.272	.326	.380	.435	.489	.543
6 1/2	.056	.113	.169	.226	.283	.339	.395	.452	.509	.565
6 3/4	.058	.117	.176	.235	.294	.352	.410	.470	.529	.587
7	.061	.122	.182	.243	.304	.365	.425	.487	.549	.609
7 1/4	.063	.126	.189	.252	.315	.378	.440	.504	.568	.630
7 1/2	.065	.130	.195	.261	.326	.391	.456	.522	.588	.651
7 3/4	.067	.135	.202	.270	.337	.404	.471	.540	.607	.673
8	.069	.139	.208	.278	.347	.417	.487	.557	.626	.695

TABLES

REAMER CLEARANCE TABLE  
(When Using Cup Wheels Only)

SIZE OF REAMER	TABLE 1 Hand Reamer for Steel. Land of Cutting Clearance .006 Wide		TABLE 2 Hand Reamer for Cast Iron and Bronze. Land of Cutting Clearance .025 Wide		TABLE 3 Chuckling Reamer for Cast Iron and Bronze. Land of Cutting Clearance .025 Wide	
	Vertical Adjustment for Cutting *Clearance	Vertical Adjustment for Second Clearance	Vertical Adjustment for Cutting Clearance	Vertical Adjustment for Second Clearance	Vertical Adjustment for Cutting Clearance	Vertical Adjustment for Second Clearance
1/2"	.012"	.052"	.032"	.072"	.040"	.080"
9/16"	.012"	.057"	.032"	.072"	.040"	.080"
5/8"	.012"	.062"	.032"	.072"	.040"	.090"
11/16"	.012"	.067"	.035"	.095"	.040"	.100"
3/4"	.012"	.072"	.035"	.095"	.040"	.100"
13/16"	.012"	.077"	.037"	.095"	.045"	.125"
7/8"	.012"	.082"	.040"	.120"	.045"	.125"
15/16"	.012"	.087"	.040"	.120"	.045"	.125"
1"	.012"	.092"	.040"	.120"	.045"	.125"
1 1/16"	.012"	.097"	.040"	.120"	.045"	.125"
1 1/8"	.012"	.102"	.040"	.120"	.045"	.125"
1 3/16"	.012"	.106"	.042"	.122"	.045"	.125"
1 1/4"	.012"	.112"	.045"	.145"	.050"	.160"
1 5/16"	.012"	.118"	.045"	.145"	.050"	.160"
1 3/8"	.012"	.122"	.045"	.145"	.050"	.160"
1 7/16"	.012"	.127"	.045"	.145"	.055"	.175"
1 1/2"	.012"	.132"	.048"	.168"	.055"	.175"
1 9/16"	.012"	.137"	.050"	.170"	.055"	.175"
1 5/8"	.012"	.142"	.050"	.170"	.060"	.200"
1 11/16"	.012"	.147"	.050"	.170"	.060"	.200"
1 3/4"	.012"	.152"	.052"	.192"	.060"	.200"
1 13/16"	.012"	.157"	.052"	.192"	.060"	.200"
1 7/8"	.012"	.162"	.056"	.196"	.060"	.200"
1 15/16"	.012"	.167"	.056"	.196"	.064"	.200"
2"	.012"	.172"	.056"	.216"	.064"	.224"
2 1/16"	.012"	.172"	.056"	.216"	.064"	.224"
2 1/8"	.012"	.172"	.059"	.219"	.064"	.224"
2 3/16"	.012"	.172"	.059"	.219"	.064"	.224"
2 1/4"	.012"	.172"	.063"	.223"	.064"	.224"
2 5/16"	.012"	.172"	.063"	.223"	.064"	.224"
2 3/8"	.012"	.172"	.063"	.223"	.068"	.228"
2 7/16"	.012"	.172"	.063"	.223"	.068"	.228"
2 1/2"	.012"	.172"	.065"	.225"	.072"	.232"
2 9/16"	.012"	.172"	.065"	.225"	.072"	.232"
2 5/8"	.012"	.172"	.065"	.225"	.075"	.235"
2 11/16"	.012"	.172"	.065"	.225"	.075"	.235"

\*See note, following page.



# TOOL ROOM

## REAMER CLEARANCE TABLES

(When Using Cup Wheels Only)

SIZE OF REAMER	TABLE 1 Hand Reamer for Steel. Land of Cutting Clearance .006 Wide		TABLE 2 Hand Reamer for Cast Iron and Bronze. Land of Cutting Clearance .025 Wide		TABLE 3 Chuckling Reamer for Cast Iron and Bronze. Land of Cutting Clearance .025 Wide	
	Vertical Adjustment for Cutting *Clearance	Vertical Adjustment for Second Clearance	Vertical Adjustment for Cutting Clearance	Vertical Adjustment for Second Clearance	Vertical Adjustment for Cutting Clearance	Vertical Adjustment for Second Clearance
2 3/4"	.012"	.172"	.065"	.225"	.077"	.237"
2 13/16"	.012"	.172"	.065"	.225"	.077"	.237"
2 7/8"	.012"	.172"	.070"	.230"	.080"	.240"
2 15/16"	.012"	.172"	.070"	.230"	.080"	.240"
3"	.012"	.172"	.072"	.232"	.080"	.240"
3 1/16"	.012"	.172"	.072"	.232"	.080"	.240"
3 1/8"	.012"	.172"	.075"	.235"	.083"	.240"
3 3/16"	.012"	.172"	.075"	.235"	.083"	.243"
3 1/4"	.012"	.172"	.078"	.238"	.083"	.243"
3 5/16"	.012"	.172"	.078"	.238"	.087"	.243"
3 3/8"	.012"	.172"	.081"	.241"	.087"	.247"
3 7/16"	.012"	.172"	.081"	.241"	.090"	.247"
3 1/2"	.012"	.172"	.084"	.244"	.090"	.250"
3 9/16"	.012"	.172"	.084"	.244"	.090"	.250"
3 5/8"	.012"	.172"	.087"	.247"	.093"	.253"
3 11/16"	.012"	.172"	.087"	.247"	.093"	.253"
3 3/4"	.012"	.172"	.090"	.250"	.097"	.257"
3 13/16"	.012"	.172"	.090"	.250"	.097"	.257"
3 7/8"	.012"	.172"	.093"	.253"	.100"	.260"
3 15/16"	.012"	.172"	.093"	.253"	.100"	.260"
4"	.012"	.172"	.096"	.256"	.104"	.264"
4 1/16"	.012"	.172"	.096"	.256"	.104"	.264"
4 1/8"	.012"	.172"	.096"	.256"	.104"	.264"
4 3/16"	.012"	.172"	.096"	.256"	.106"	.266"
4 1/4"	.012"	.172"	.096"	.256"	.106"	.266"
4 5/16"	.012"	.172"	.096"	.256"	.106"	.266"
4 3/8"	.012"	.172"	.096"	.256"	.108"	.268"
4 7/16"	.012"	.172"	.096"	.256"	.108"	.268"
4 1/2"	.012"	.172"	.100"	.260"	.108"	.268"
4 9/16"	.012"	.172"	.100"	.260"	.108"	.268"
4 5/8"	.012"	.172"	.100"	.260"	.110"	.270"
4 11/16"	.012"	.172"	.100"	.260"	.110"	.270"
4 3/4"	.012"	.172"	.104"	.264"	.114"	.274"
4 13/16"	.012"	.172"	.104"	.264"	.114"	.274"
4 7/8"	.012"	.172"	.106"	.266"	.116"	.276"
4 15/16"	.012"	.172"	.106"	.266"	.116"	.276"
5"	.012"	.172"	.110"	.270"	.118"	.278"
5 3/8"	.012"	.172"	.118"	.278"		

\*Note—If a cylindrical grinding attachment is available, use it for grinding the cutting clearance. (See page 38.) Then the first column should be disregarded.

*Offices and Works*

CINCINNATI MILLING MACHINES, LTD.

Woodlands Farm Road.....Tyburn  
Birmingham, England

cc:

SALES REPRESENTATIVES

*British Isles*

MESSRS. CHARLES CHURCHILL & CO., LTD.

London SE-11.....Walnut Tree Walk, Kennington  
Birmingham.....1323, Coventry Road, South Yardley  
Manchester.....46, Princess Street  
Glasgow.....238, West George Street

*London Agents for India, Burma, Crown Colonies,  
Egypt and Sudan*

J. B. CORRIE & CO., LTD.

London, S.W.1.....15, Victoria Street

Telegrams: Correlate, London  
Telephone: Abbey 6644

*With Resident Agents in:*

*India*

HEATLY & GRESHAM, LTD.

Calcutta.....P.O. Box 190, 6, Waterloo St.

*Egypt*

M. AHMED ABOUD

Egypt.....P. O. Box No. 2051

Publication No. M-737-E (January, 1939)

Reprinted September, 1941.

Printed  
England