

# CLAUSING

**10 - inch  
precision  
lathes**

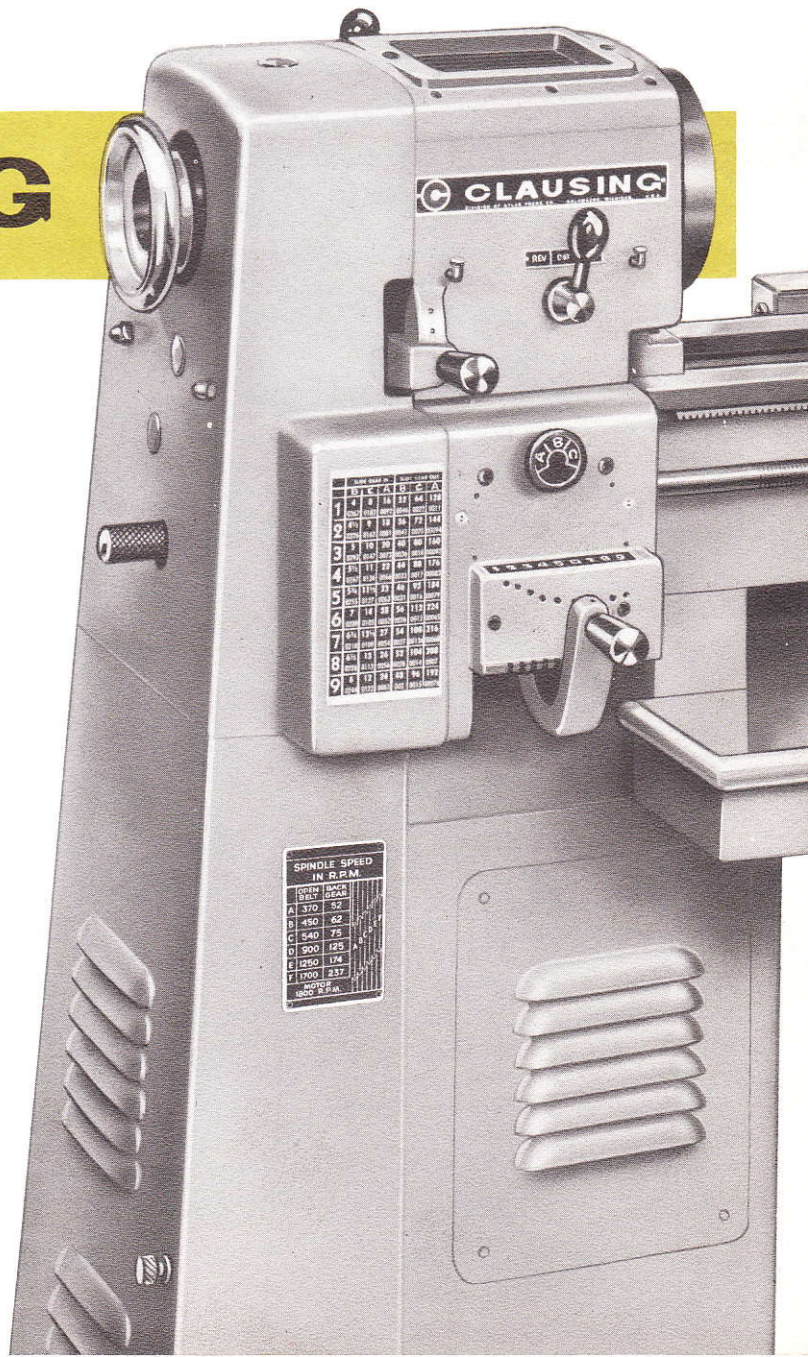

SPINDLE SPEED IN R.P.M.	
1000	1000
A 370	52
B 450	62
C 540	75
D 500	125
E 250	174
F 1700	232
1800 R.P.M.	



# CLAUSING 10" precision lathes

*\*12 speeds – 52 to 1700 rpm*

*\*1 1/16" hole thru spindle*

*\*Flame hardened bed ways*

  
TIMKEN BEARING  
EQUIPPED

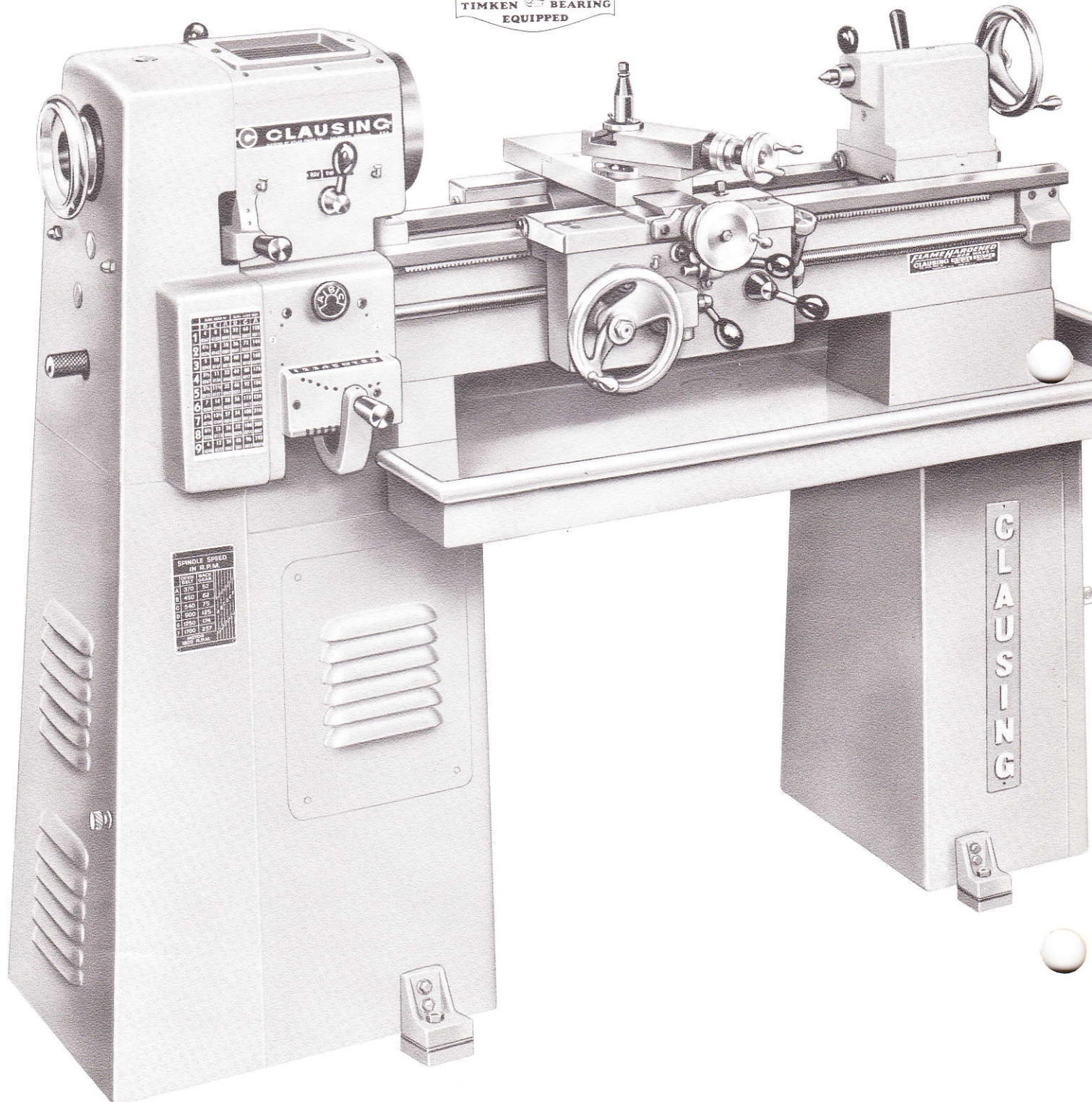



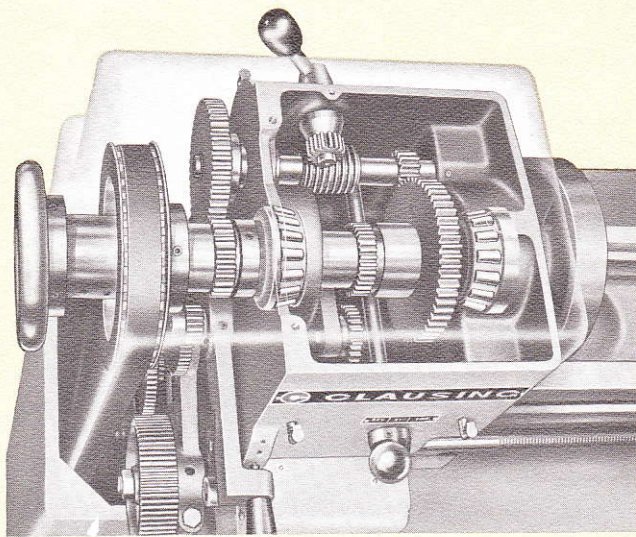

### ENCLOSED HEADSTOCK—1-1/16" SPINDLE HOLE

Rigid box-type headstock — a precision housing — is hand fitted to bed ways. Headstock is enclosed — all controls, including those for back gears, are outside for safe, efficient operation. And, switch lever is interlocked to prevent engagement of back gears while lathe is running, or accidental reversing of spindle.

Forged spindle is chrome-moly steel. Has hardened nose, ground threads—turns on Timken tapered roller bearings. Spindle has 1-1/16" bore — larger thru-spindle work capacity.

**BALL BEARING QUICK-CHANGE** provides 54 feeds and threads (including 11½ and 27) without change of gear train. Stack gear shaft and lead screw turn on lubricated-for-life ball bearings.

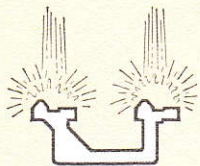

**FLAME HARDENED  
BED WAYS**

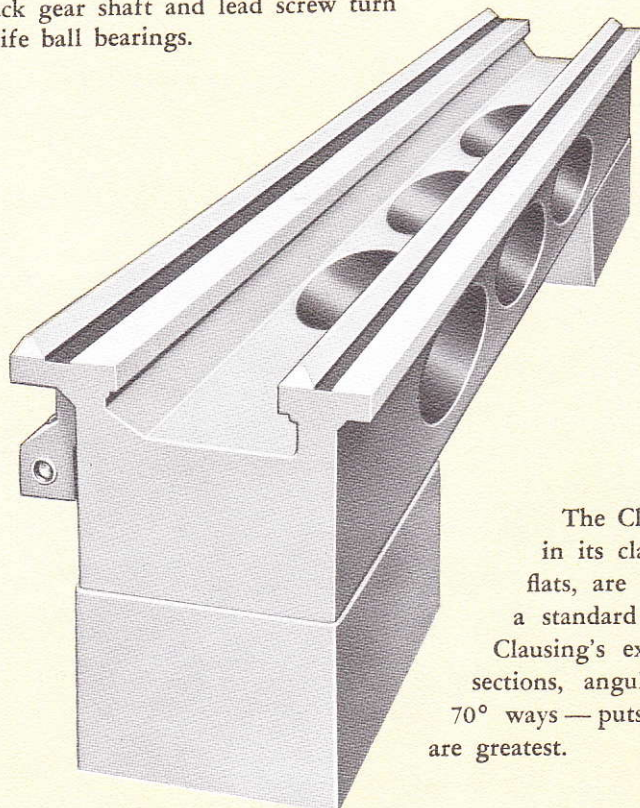

### ELLIPTICALLY BRACED PORTED BED

The Clausing lathe bed is the largest and heaviest in its class. And, all four ways, two V's and two flats, are *flame hardened* and precision ground — a standard feature that adds years to accuracy life. Clausing's exclusive bed design — with solid box end sections, angular way supports, elliptical bracing, and 70° ways — puts maximum strength where turning forces are greatest.

### CARRIAGE, POWER FEEDS

The husky carriage is engineered to take full advantage of Clausing's wider work range.

Hand fitted saddle bears a full 11-inches on bed ways. Wide, deep bridge provides a rigid support for the cutting tool.

Power feed gear shafts in apron are supported at both ends. Feeds are engaged thru fast-acting positive clutches — lead screw threads are used for thread cutting only. Indicator dial, furnished, simplifies threading. Feed screws have Acme threads, large micrometer graduated dials.

Safety clutch in apron and shear pin in lead screw protect against overload. Safety-interlock prevents engaging half nuts and longitudinal feed at same time.



## **Cog belt, cog pulleys drive spindle — greater efficiency — more power — smoother operation**

Tooth grip, not friction, transmits power from countershaft to spindle — teeth in belt mesh with teeth in pulleys — belt load on spindles and bearings is at a minimum.

Countershaft and spindle drive pulley turn on heavy-duty lubricated-for-life ball bearings. All pulleys are accurately machined, and entire drive is dynamically balanced after motor is installed.

*This modern drive permits you to take full advantage of Clausing's superior construction and capacity — power for heavy cuts, smoothness for close tolerances, speeds for top efficiency with today's metals and tools.*

### **UNIT ENGINEERED—ANOTHER CLAUSING EXCLUSIVE**

The headstock, bed and pedestal are designed to form an integral unit — basic to Clausing's greater rigidity, capacity, accuracy and superior performance.

Pedestals are  $\frac{1}{4}$ " steel plate with welded reinforcements. Tailstock pedestal has storage shelves.

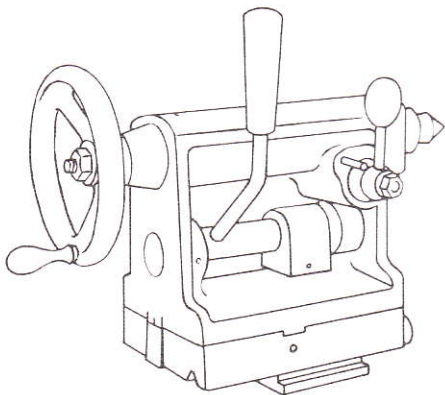

**CAM-LOCK  
TAILSTOCK**

A 28-pound work support, hand fitted to the bed ways.

Quick to position, quick to lock — one movement of the lever anchors tailstock to bed or releases it — no wrenches.

Has  $\frac{3}{4}$ " set-over for taper work. Ram is graduated 0 to  $2\frac{1}{2}$ " by 16ths.

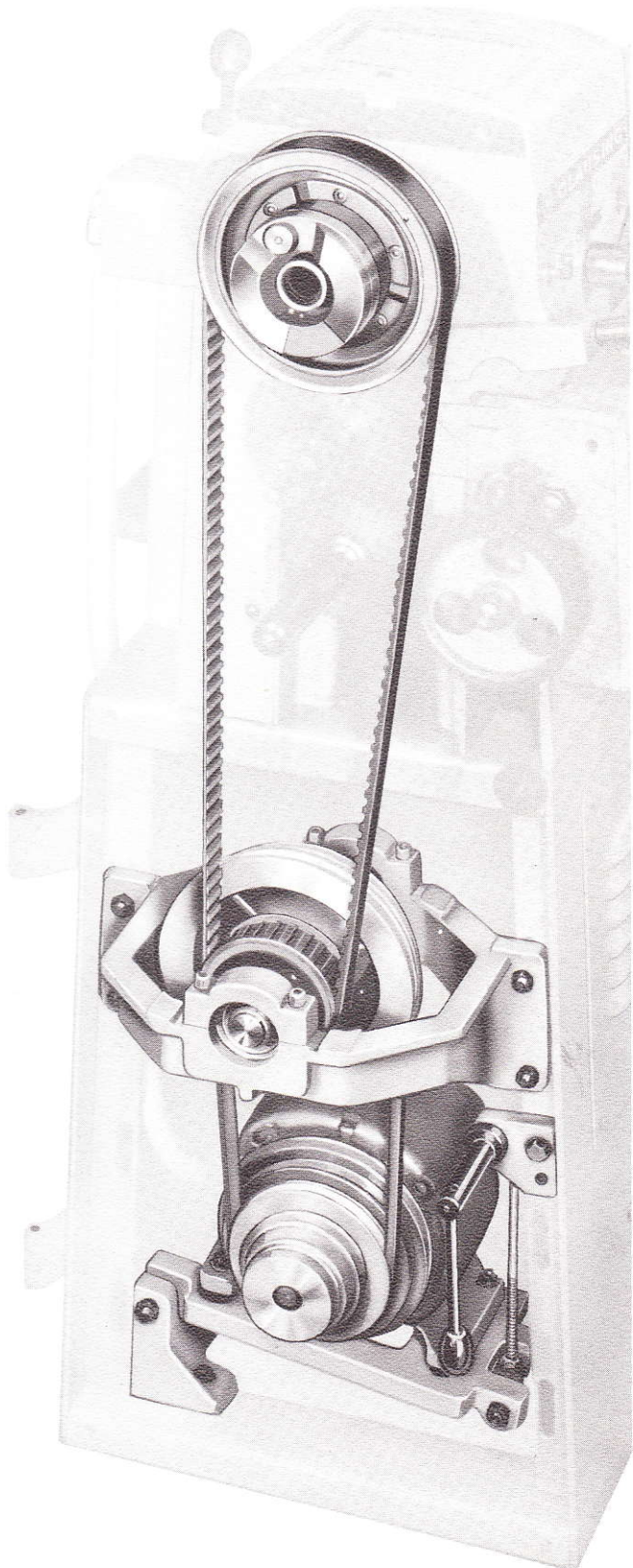



# SPECIFICATIONS

*Make any comparison—specification for specification, feature for feature—the Clausing 10 offers more PLUS VALUE than any lathe in its class.*

## CAPACITIES

Swing over bed and saddle wings	10 $\frac{1}{8}$ "	10
Swing over cross slide	5 $\frac{1}{2}$ "	6 $\frac{1}{4}$
Hole through spindle	1 $\frac{3}{16}$ "	
Collet capacity—spindle nose type	1"	27/32
Collet capacity—draw-bar type	3/4"	5/8
Distance between centers	24", 36"	22-34

## SPINDLE SPEEDS

Number	12
Direct drive	370, 450, 540, 900, 1250, 1700 rpm
Back gear drive	52, 62, 75, 125, 174, 237 rpm

## THREADS AND FEEDS

Number, threads and feeds	54
Longitudinal feed range	.00065" to .0367"
Cross feed range	.00016" to .00917"
Thread range, Standard right or left	4 to 224
Screw threads per inch	4, 4 $\frac{1}{2}$ , 5, 5 $\frac{1}{2}$ , 5 $\frac{3}{4}$ , 6, 6 $\frac{1}{2}$ , 6 $\frac{3}{4}$ , 7, 8, 9, 10, 11, 11 $\frac{1}{2}$ , 12, 13, 13 $\frac{1}{2}$ , 14, 16, 18, 20, 22, 23, 24, 26, 27, 28, 32, 36, 40, 44, 46, 48, 52, 54, 56, 64, 72, 80, 88, 92, 96, 104, 108, 112, 128, 144, 160, 176, 184, 192, 208, 216, 224
Lead screw	3/4" dia., 8 Acme t.p.i.

## HEADSTOCK

Hole through spindle	1 $\frac{1}{16}$ "	27/32
Spindle nose	hardened, ground threads, 1 $\frac{3}{4}$ "-8	1 $\frac{1}{2}$ -8
Spindle nose internal taper	4 M.T.	
Spindle center	2 M.T.	
Spindle bearings	two Timken tapered roller	

## BED

Flame-hardened ways	two 70° V-ways, two flat ways
Depth	5 $\frac{7}{8}$ "
Width	7 $\frac{3}{8}$ "
Length	44", 56"

## CARRIAGE

Length on bed	11"
Width of bridge	3 $\frac{3}{4}$ "
Cross slide travel	7 $\frac{1}{2}$ "
Compound rest	graduated 0-90° left and right
Compound rest travel	2 $\frac{1}{2}$ "
Tool post	takes 3/8" tool bits or holder for 1/4" bit

## TAILSTOCK

Spindle center	2 M.T.
Spindle diameter	1 $\frac{1}{8}$ "
Spindle travel	2 $\frac{3}{4}$ "
Spindle graduated	0-2 $\frac{1}{2}$ " by 16ths
Set-over	3/4"

## DRIVE

Drive to countershaft	5-step pulleys, V-belt
Drive to spindle	positive-grip timing belt
Motor, 1725 rpm furnished	3/4 or 1 HP, optional
Reversing switch furnished	across-the-line drum

(Note: Motor and switch are installed and factory tested.)

STANDARD EQUIPMENT, all models: flame-hardened bed ways, chip and coolant pan, motor, reversing switch, 6" face plate, two centers, center sleeve, tool post, threading dial, wrenches and instruction book. (Design and specifications are subject to change without notice.)

10" LATHES			
Model Number	Between Centers	Motor Furnished (specify voltage)	Ship. Wt.
4901	24"	3/4 hp, single phase	845
4902	24"	3/4 hp, three phase	845
4903	24"	1 hp, single phase	860
4904	24"	1 hp, three phase	860
4911	36"	3/4 hp, single phase	900
4912	36"	3/4 hp, three phase	900
4913	36"	1 hp, single phase	915
4914	36"	1 hp, three phase	915

Single-phase motors are capacitor start, 115/230V, 60C. Three-phase motors — 208/220/440V, 60C\*. All motors ball bearing equipped. \*Operate on 50 Cycle at 1425 rpm.

## OPTIONAL ELECTRICAL EQUIPMENT

### For Factory Installation Only

(Controls for field installation—price on application.)

**No. 7030 MAGNETIC STARTER**, for 3 phase\*, with Drum Reversing Control. Protects motor against overload, low and no voltage. Motor will not automatically restart when power is restored—drum control† has momentary contactors.

**No. 7032 MAGNETIC REVERSING STARTER**, for 3 phase\*, WITH 110 VOLT AT DRUM CONTROL. Protects motor against overload, low and no voltage. Motor will not automatically restart when power is restored—drum control† has momentary contactors.













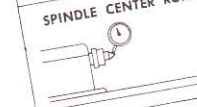
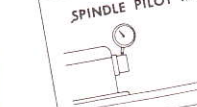

**No. 7033 THERMAL OVERLOAD UNIT**, for 1 or 3 phase. Automatically cuts out to prevent damage to motor from overheating. Has manual reset button. Installed between drum switch and motor.

\*Magnetic starter for single phase—price on application.

†Operated by standard lever on headstock.



# CLAUSING TEST REPORT, 4900-series LATHE

TEST	LIMIT	ACTUAL
 BED LEVEL (Transverse Direction)	When Using Precision Level All Readings to Be Within 0.0005 in 12 In.	
 BED LEVEL (Longitudinal Direction)	When Using Precision Level Along Bed Maximum Reading to Be Within 0.001 in 12 In.	
 SPINDLE CENTER RUNOUT	Total Indicator Reading 0 to 0.0008	
 SPINDLE PILOT RUNOUT	Total Indicator Reading 0 to 0.0005	
 SPINDLE TAPER RUNOUT	Total Indicator Reading at End of 12 In. Test Bar 0 to 0.0006 at End of Spindle Nose 0 to 0.0003	
 HEADSTOCK ALIGNMENT (Vertical)	High at End of 12 In. Test Bar 0 to 0.0005	
 TAILSTOCK SPINDLE Alignment (Vertical)	High at End of Spindle When Fully Extended 0 to 0.0008	
 HEADSTOCK ALIGNMENT (Horizontal)	At End of 10 In. Test Bar 0 to $\pm 0.0003$	
 TAILSTOCK SPINDLE Alignment (Horizontal)	Forward at End of Spindle When Fully Extended 0 to 0.0005	
 TAILSTOCK TAPER Alignment (Horizontal)	End of 12 In. Test Bar 0 to $\pm 0.0005$	
 TAILSTOCK TAPER Alignment (Vertical)	High at End of 12 In. Test Bar 0 to 0.001	
 A - CROSS SLIDE ALIGNMENT B - FACE PLATE RUNOUT	To Face Concave Only on 10 In. Diameter 0 to 0.0005 On Face at Diameter 0 to 0.0005	
 LATHE MUST TURN ROUND WITH WORK MOUNTED IN CHUCK	0.0003	
 RUNNING TEST FOR SMOOTH OPERATION 1 1/2" DIA. C.R.S. 0.0025 FEED 0.125 DEPTH AT HIGH SPEED	Lathe Must Take Cut Without Chatter	
 BACK LASH ON CROSS FEED SCREW	0.004	

INSPECTED BY \_\_\_\_\_ NO. \_\_\_\_\_  
DATE \_\_\_\_\_

Each Clausing lathe must pass tolerance tests similar to those shown at left. Inspection after inspection, and test after test — at every stage of manufacture and assembly — assure that every lathe measures up to rigid specifications of construction and performance.

The test report that accompanies each lathe verifies its precision.

For 4900-series lathe accessories... see Catalog 7071-5

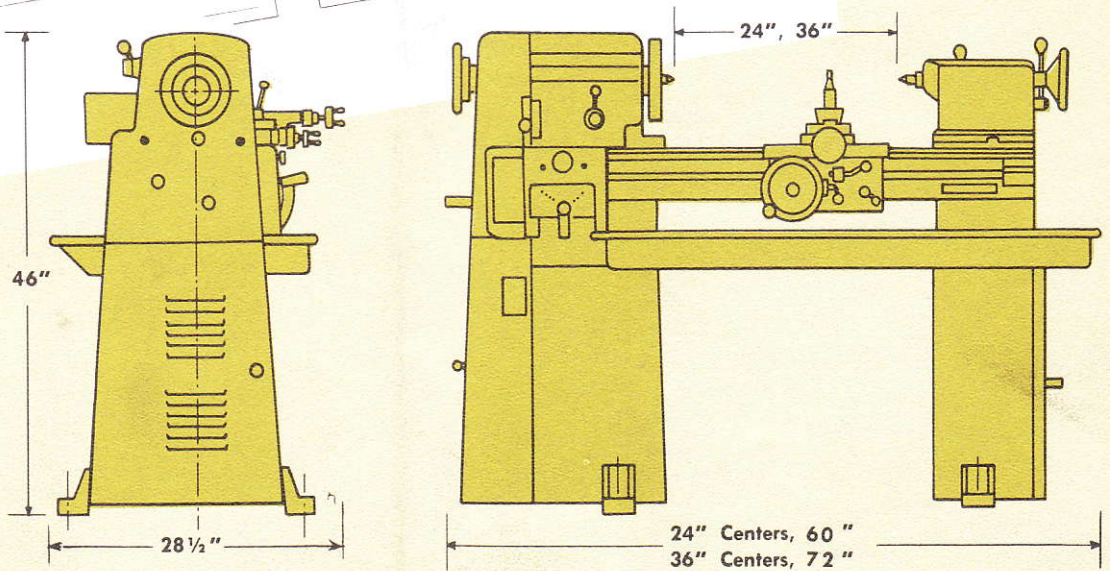

**CLAUSING**

DIVISION OF ATLAS PRESS COMPANY

SINCE 1911, MANUFACTURERS OF PRECISION MACHINE TOOLS  
1915-2023 N. PITCHER ST., KALAMAZOO, MICH., U. S. A.

PRINTED IN U.S.A.

Ph. Area Code: 616 345-7155

11661B30