

# **USER'S MANUAL**

## **RG300 and RG400 Series**

SCR, Adjustable Speed, Regenerative Drives  
for DC Brush Motors

Copyright © 1998 by  
Minarik Corporation

All rights reserved. No part of this manual may be reproduced or transmitted in any form without written permission from Minarik Corporation. The information and technical data in this manual are subject to change without notice. Minarik Corporation and its Divisions make no warranty of any kind with respect to this material, including, but not limited to, the implied warranties of its merchantability and fitness for a given purpose. Minarik Corporation and its Divisions assume no responsibility for any errors that may appear in this manual and make no commitment to update or to keep current the information in this manual.

Printed in the United States of America.

---

## Safety Warnings

- This symbol  denotes an important safety tip or warning. Please read these sections carefully prior to performing any of the instructions contained in that section.
- Have a qualified electrical maintenance technician install, adjust and service this equipment. Follow the National Electrical Code and all other applicable electrical and safety codes, including the provisions of the Occupational Safety and Health Act (OSHA), when installing equipment.
- Reduce the chance of an electrical fire, shock, or explosion by proper grounding, over-current protection, thermal protection, and enclosure. Follow sound maintenance procedures.
- **It is possible for a drive to run at full speed as a result of a component failure.** Please ensure that a master switch has been placed in the AC line to stop the drive in an emergency.
- **This drive is isolated from earth ground.** Circuit potentials are at 115 VAC or 230 VAC above earth ground. Avoid direct contact with the printed circuit board or with circuit elements to prevent the risk of serious injury or fatality. Use a non-metallic screwdriver for adjusting the calibration trimpots.

---

# Contents

<b>Specifications</b>	<b>1</b>
<b>Dimensions</b>	<b>3</b>
<b>Regenerative Drives</b>	<b>6</b>
<b>Installation</b>	<b>8</b>
Mounting chassis drives . . . . .	8
Mounting cased drives . . . . .	9
Cage-clamp terminal block . . . . .	11
Screw terminal block . . . . .	12
Heat sinking . . . . .	13
AC line and motor connection . . . . .	13
Field output . . . . .	15
Speed adjust potentiometer installation . . . . .	16
Speed adjust potentiometer connections . . . . .	17
Line fusing for RG300/400 Series . . . . .	18
Voltage follower . . . . .	19
<b>Operation</b>	<b>20</b>
Before applying power . . . . .	20
Startup . . . . .	20
Chassis drives . . . . .	20
Cased drives . . . . .	21
Line starting and line stopping . . . . .	22
Automatic restart upon power restoration . . . . .	21
Regenerative deceleration . . . . .	21
Regenerative brake . . . . .	23
Decelerate to minimum speed . . . . .	24

Warning .....	.25
<b>Calibration</b>	<b>26</b>
MIN SPD .....	.26
MAX SPD .....	.26
FWD TQ .....	.27
REV TQ .....	.28
IR COMP .....	.29
FWD ACC .....	.31
REV ACC .....	.31
DB .....	.32
<b>Application Notes</b>	<b>33</b>
Connection to other Minarik devices .....	.33
Optional speed adjust potentiometer connections .....	.35
<b>Troubleshooting</b>	<b>38</b>
<b>Block Diagram</b>	<b>43</b>
<b>Factory Prewired Connections (for Cased Drives)</b>	<b>44</b>
<b>CE Compliance</b>	<b>46</b>
Line filters .....	.47
Armature filters .....	.48
<b>Replacement Parts</b>	<b>50</b>
<b>Limited Warranty</b>	<b>inside back cover</b>

---

# Illustrations

<b>Fig.</b>	<b>Description</b>	<b>Page</b>
1.	RG300UA, RG310UA and RG400UA Dimensions . . . . .	3
2.	RG300UA-S, RG310UA-S and RG400UA-S Dimensions . . . . .	4
3.	Cased Drive Dimensions . . . . .	5
4.	Four-Quadrant Operation . . . . .	7
5.	Cage-Clamp Terminal Block . . . . .	11
6.	Screw Terminal Block . . . . .	12
7.	Chassis Drive Connections . . . . .	13
8.	Cased Drive Connections . . . . .	14
9.	Speed Adjust Potentiometer Installation . . . . .	16
10.	Speed Adjust Potentiometer Connections . . . . .	17
11.	Voltage follower . . . . .	19
12.	Regenerative Deceleration Switch connection . . . . .	22
13.	Run/Decelerate to Minimum Speed Switch . . . . .	24
14.	Typical FWD TQ, REV TQ and IR COMP Settings . . . . .	30
15.	Deadband Settings . . . . .	32
16.	Connection to Other Minarik Devices . . . . .	33
17.	RG300/400 Connection to 200-0386A Logic Board . . . . .	34
18.	FWD-REV Switch . . . . .	35
19.	FWD-STOP-REV Switch . . . . .	35
20.	Independent Adjustable Speeds . . . . .	36
21.	Independent Forward and Reverse Speeds . . . . .	36
22.	Independent Forward and Reverse Speed with FWD-STOP-REV Switch . . . . .	37
23.	RG300/400 Series Block Diagram . . . . .	43
24.	Prewired Power Input Connections . . . . .	44
25.	Prewired Speed Adjust Potentiometer Connections . . . . .	45

---

# Tables

<b>Table</b>	<b>Description</b>	<b>Page</b>
1.	Field Output Connections . . . . .	.15
2.	Line Fusing for RG Series Drives . . . . .	.18
3.	Corcom® Filters for CE Compliance . . . . .	.47
4.	Minarik® Filters for CE Compliance . . . . .	.48
5.	Replacement Parts . . . . .	.50





# Specifications

Model	Maximum Armature Current	Armature Voltage	Horsepower Range
RG310	3.0 ADC	0 – 90 VDC	1/20 – 1/8
RG300	10.0 ADC †	0 – 90 VDC	1/4 – 1 †
RG400	10.0 ADC †	0 – 180 VDC	1/2 – 2 †

† Maximum armature current and horsepower range apply when drive is attached to additional heat sink: Minarik part number 223-0235. Use heat sink when armature current is above 5 ADC. Heat sinks are pre-mounted on RG300 and RG400 series cased drives.

## AC Line Voltage

**RG300/RG310**

115 VAC, ±10%, 50/60 Hz, single phase

**RG400**

230 VAC, ±10%, 50/60 Hz, single phase

## Form Factor

1.37 at base speed

## Field Voltage

**115 VAC Input**

50 VDC (F1 to L1); 100 VDC (F1 to F2)

**230 VAC Input**

100 VDC (F1 to L1); 200 VDC (F1 to F2)

## Maximum Field Current

1 ADC

## Acceleration Time Range

0.5 – 6 seconds

## Deceleration Time Range

0.5 – 6 seconds

## Analog Input Voltage Range (isolated; RB1 to S2)

–10 VDC to +10 VDC

## Input Impedance (RB1 to S2)

32K $\Omega$

## Load Regulation

1% of base speed or better

## Vibration

0.5G max. (0 – 50 Hz)

0.1G max. (>50Hz)

## Ambient Temperature Range (chassis drive)

10°C – 55°C

## Ambient Temperature Range (cased drive)

10°C – 40°C

## Safety Certification

UL file # E132235

CSA file # LR41380

CE Certificate of Compliance

---

**Drive option description - by suffix**

---

<b>Suffix</b>	<b>Style</b>	<b>Terminal Block Type</b>
A	NEMA 4	Cage-Clamp*
A-S	NEMA 4	Screw
UA	Chassis	Cage-Clamp*
UA-S	Chassis	Screw

---

\*Note: All cased regenerative drives in this series have a two slot screw terminal block for connecting the AC line voltage (see page 18).

# Dimensions

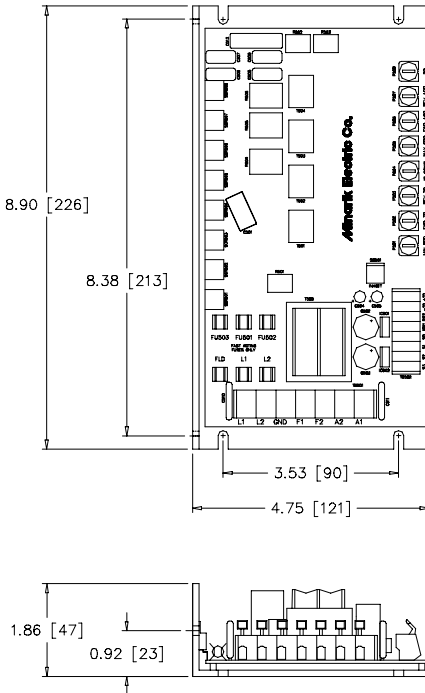

ALL DIMENSIONS IN INCHES [MILLIMETERS]

Figure 1. RG300UA, RG310UA, and RG400UA Dimensions

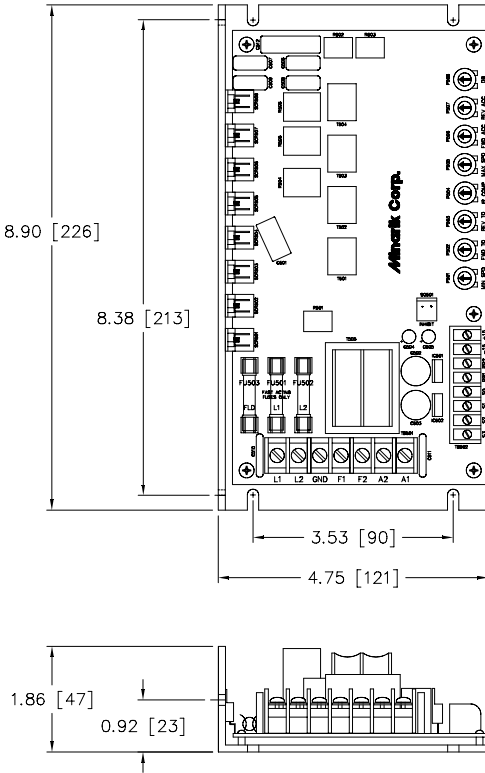

ALL DIMENSIONS IN INCHES [MILLIMETERS]

Figure 2. RG310UA-S, RG300UA-S, RG400UA-S,  
Dimensions

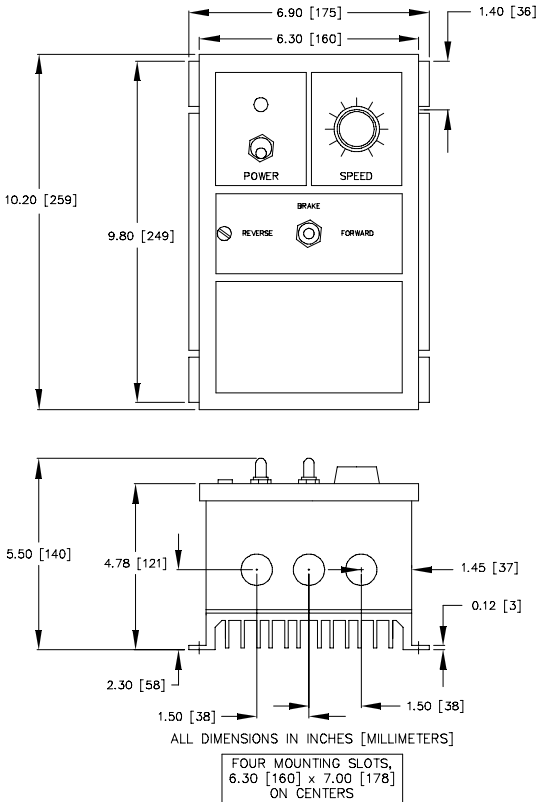

Figure 3. RG310A, RG300A, RG400A  
and RG310A-S, RG300A-S, RG400A-S  
Cased Drive Dimensions

## Regenerative Drives

Most non-regenerative, variable speed, DC drives control current flow to a motor in one direction. The direction of current flow is the same direction as the motor rotation. Non-regenerative drives operate in Quadrant 1, and also in Quadrant 3 if the drive is reversible (see Figure 4). Motors must stop before reversing direction. Unless dynamic braking is used, non-regenerative drives cannot oppose an overhauling load, and cannot decelerate a load faster than coasting to a lower speed.

Regenerative drives operate in two additional quadrants: Quadrant 2 and Quadrant 4. In these quadrants, motor torque is in the opposite direction of motor rotation.

Regenerative drives can reverse a motor without contactors, switches, brake resistors, and inhibit plugs. They can also control an overhauling load and decelerate a load faster than it would take to coast to a lower speed.

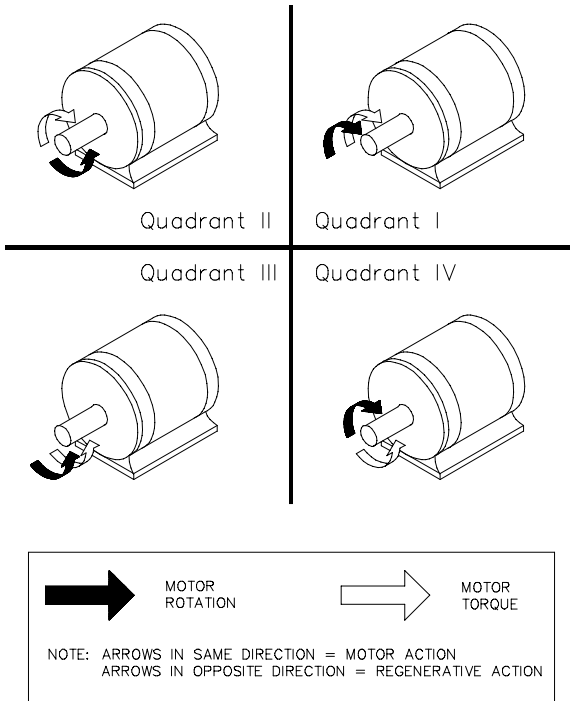

Figure 4. Four Quadrant Operation

## Installation

**ASSUMPTIONS:** Minarik drives supply motor voltage from A1 and A2 terminals. It is assumed throughout this manual that, when A1 is positive with respect to A2, the motor will rotate clockwise (CW) while looking at the output shaft protruding from the front of the motor. If this is opposite of the desired rotation, simply reverse the wiring of A1 and A2 with each other.

### Mounting chassis drives

Drive components are sensitive to electrostatic fields. Avoid contact with the circuit board directly. Hold the drive by the chassis only.

Protect the drive from dirt, moisture, and accidental contact. Provide sufficient room for access to the terminal block and calibration trimpots.

Mount the drive away from other heat sources. Operate the drive within the specified ambient operating temperature range.

Prevent loose connections by avoiding excessive vibration of the drive.



Mount the drive with its board in either a horizontal or vertical plane. Six 0.188 inch (4.8 mm) wide slots in the chassis accept #8 pan head screws. Fasten either the large base or the narrow flange of the chassis to the subplate.

The chassis must be earth grounded for noise suppression. To ground the chassis, connect earth ground to the GND terminal on terminal block 501 (TB501).

### **Mounting cased drives**

NEMA 4X cased drives come with three 0.88 inch (22 mm) conduit knockout holes at the bottom of the case. The units may be vertically wall mounted using the four 0.188 inch (5 mm) slotted holes on the attached heat sink. The cased drives in this series may be bench mounted. For motor loads greater than 8 ADC the heat sink fins must be in the vertical direction. Detailed step by step instructions begin on the page 14.

## **Mounting cased drives (continued)**

1. Install the mounting screws.
2. For access to the terminal strip, turn the slotted screw on the front cover counterclockwise until it is free from the case. The right side of the cover is hinged to the case. Lift or pull the slotted screw to open the case.
3. Carefully remove the conduit knockouts by tapping them into the case and twisting them off with pliers.
4. Install conduit hardware through the 0.88 inch (22 mm) conduit holes. Connect external wiring to the terminal block.
5. Grasp the slotted screw and tilt the front cover back into place. Avoid pinching any wires between the front cover and the case.
6. Turn the slotted screw clockwise until tight to secure the front cover.
7. Set the POWER switch OFF position before applying the AC line voltage.

---

## Cage-clamp terminal block

Most connections to RG300 and RG400 Series drives (UA and A versions) are made to a cage-clamp terminal block (Figure 5). To insert a wire into the terminal block, press down on the lever arm using a small screwdriver. Insert stripped wire into the large opening in front of the terminal block. Release the lever arm to clamp the wire.

Note: All AC line voltage connections to cased regen drives are made to screw terminals.

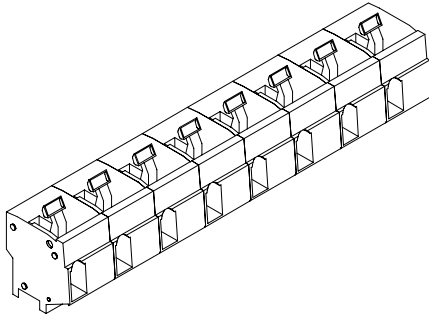

Figure 5. Cage-Clamp Terminal Block

## Screw terminal block

Connections to RG300 and RG400 Series drives (A-S version and UA-S) are made to screw terminal blocks. The larger one is shown in Figure 6.

Using a screwdriver, turn the terminal block screw counter-clockwise to open the wire clamp. Insert stripped wire into the wire clamp. Turn the terminal block screw clockwise to clamp the wire.

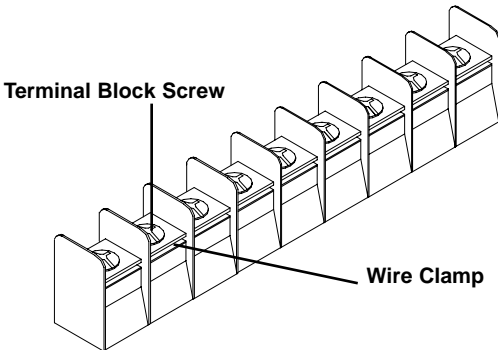

Figure 6. Screw Terminal Block

## Heat sinking

Chassis RG models require an additional heat sink when the continuous armature current is above 5 ADC. Use Minarik® part number 223-0235. All cased drives have sufficient heat sinking in their basic configurations. Use a thermally conductive heat sink compound (such as Dow Corning® 340 Heat Sink compound) between the drive chassis and the heat sink surface for optimum heat transfer.

## AC line and motor connections

Use 12 AWG or 14AWG standard wire for connecting the line and the armature. Strip the wire insulation 0.25 inches (6 mm). See Figures 7 and 8 for AC line and motor connections to chassis and cased drives.

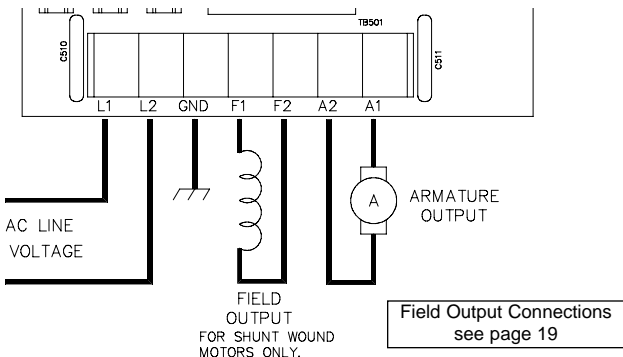

Figure 7. Chassis Drive Connections

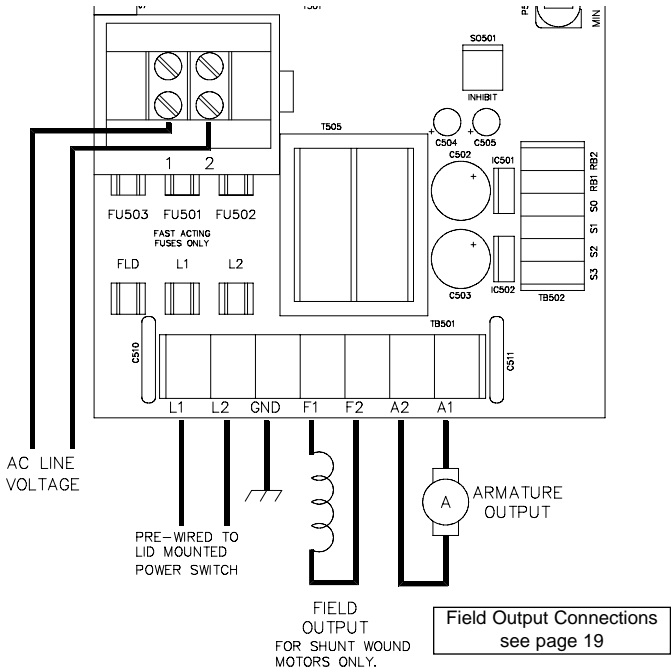

Figure 8. Cased Drive Connections

---

## Field output

The field output is for shunt wound motors only. **Do not make any connections to F1 and F2 when using a permanent magnet motor.**

Use 18 AWG wire to connect the field output to a shunt wound motor. Table 1 lists the field output connections.

**Table 1. Field Output Connections**

<b>Line Voltage (VAC)</b>	<b>Approximate Field Voltage (VDC)</b>	<b>Connect Motor Field To</b>
115	50	F1 and L1
115	100	F1 and F2
230	100	F1 and L1
230	200	F1 and F2

## Speed adjust potentiometer installation

Speed adjust potentiometers are pre-installed on all cased drives. On chassis drives, install the circular insulating disk between the panel and the 10K $\Omega$  speed adjust potentiometer. Mount the speed adjust potentiometer through a 0.38 in. (0.96 cm) hole with the hardware provided (see Figure 9). Twist the speed adjust potentiometer wire to avoid picking up unwanted electrical noise. If potentiometer leads are longer than 18 in. (46 cm), use shielded cable.

**⚠ Warning** Be sure that the potentiometer tabs do not make contact with the potentiometer enclosure. Grounding the input will cause damage to the drive.

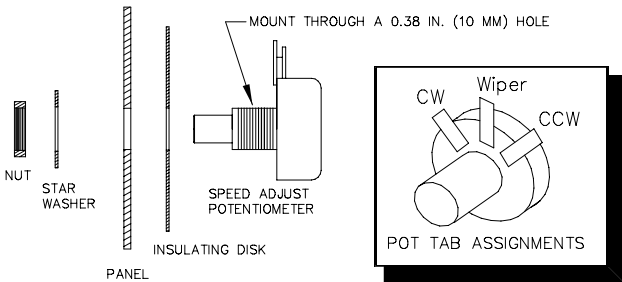

Figure 9. Speed Adjust Potentiometer



## Speed adjust potentiometer connections

The motor can operate in one direction (unidirectional) or in two directions (bidirectional) depending on how the speed adjust potentiometer is connected to the drive.

Connect the speed adjust potentiometer as shown in Figure 10(a) for speed control in one direction.

Connect the speed adjust potentiometer as shown in Figure 10(b) for speed control in two directions. The motor does not rotate when the wiper is in the center position. Turning the wiper CW from the center position causes the motor to rotate in one direction, while turning the wiper CCW from the center position causes the motor to rotate in the opposite direction.

Refer to the Application Notes section for additional speed adjust potentiometer connections.

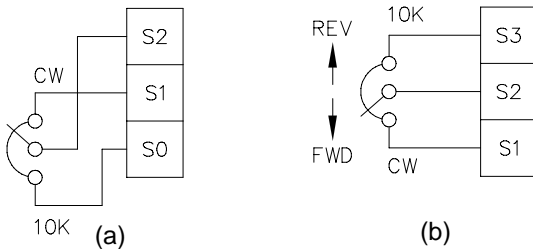

Figure 10. Speed Adjust Potentiometer Connections for (a) Unidirectional Operation, and (b) Bidirectional Operation

## Line fuses

Minarik drives require fuses for protection. Use fast acting fuses rated for 250 VAC or higher, and approximately 150% of the maximum armature current. Fuse only L1 when the line voltage is 115 VAC. Fuse both L1 and L2 when the line voltage is 230 VAC.

Table 2 lists the recommended line fuse sizes.

**Table 2. Recommended Line Fuse Sizes**

90 VDC Motor Horsepower	180 VDC Horsepower	Max. DC Armature Current (amps)	AC Line Fuse Size (amps)
1/20	1/10	0.5	3
1/15	1/8	0.8	3
1/8	1/4	1.5	5
1/6	1/3	1.7	5
1/4	1/2	2.6	8
1/3	3/4	3.5	8
1/2	1	5.0	10
3/4	1 1/2	7.6	15
1	2	10	20

Minarik Corporation offers two fuse kits: part number 050-0069 (3-8A Fuse Kit) and 050-0073 (5-20A Fuse Kit). Both fuse kits include a 1/2A pico fuse (part number 050-0064) which protects the transformer and logic.

## Voltage follower

The drive may be wired to follow a floating (isolated) 0 to  $\pm 10$  VDC signal that is isolated from earth ground instead of using a speed adjust potentiometer. Connect the signal input to S2, and the signal common to RB1 (see Figure 11).

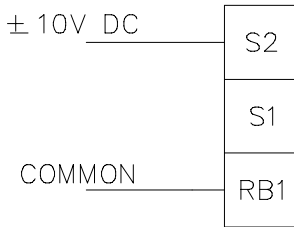

Figure 11. Voltage Follower Connection

# Operation

## Before applying power

1. Check connections before applying AC line voltage to the drive.
2. Check that no conductive material is present on the printed circuit board.

## Startup

### Chassis drives

1. Set the speed adjust potentiometer for zero speed.
2. Apply AC line voltage.
3. Slowly advance the speed adjust potentiometer clockwise (CW). The motor slowly accelerates as the potentiometer is turned CW. Continue until the desired speed is reached.
4. Remove AC line voltage from the drive to coast the motor to a stop.

## **Cased drives**

1. Set the FORWARD/BRAKE/REVERSE switch to the BRAKE position.
2. Set the speed adjust potentiometer to “0” (full CCW).
3. Apply AC line voltage.
4. Set the POWER switch to the ON position.
5. Set the FORWARD/BRAKE/REVERSE switch to the desired direction of rotation.
7. Slowly advance the speed adjust potentiometer clockwise (CW). The motor slowly accelerates as the potentiometer is turned CW. Continue until the desired speed is reached.
8. To brake the motor, set the FORWARD/BRAKE/REVERSE switch to the BRAKE position. To coast the motor to a stop, set the POWER switch to the OFF position.
9. To reverse direction:
  - a. Set the FORWARD/BRAKE/REVERSE switch to the BRAKE position.
  - b. After the motor comes to a complete stop, set the FORWARD/BRAKE/REVERSE switch to the desired direction of rotation.
10. Set the POWER switch to OFF to remove power from the drive.

## Line starting and line stopping

Line starting and line stopping (applying and removing AC line voltage) is recommended for infrequent starting and stopping of a drive only. When AC line voltage is applied to the drive, the motor accelerates to the speed set by the speed adjust potentiometer. When AC line voltage is removed, the motor coasts to a stop.

## Automatic restart upon power restoration

All drives automatically run to set speed when power is applied. Wiring a latching relay into the AC line is one way to prevent automatic restarting following a power outage.

## Regenerative deceleration

Short terminals RB1 and RB2 to regeneratively decelerate a motor to a stop (Figure 12). Since terminal RB1 bypasses the MIN SPD circuit, shorting RB1 and RB2 will decelerate a motor to a stop instead of minimum speed. Calibrate the deceleration time by adjusting the opposite-direction acceleration trimpot.

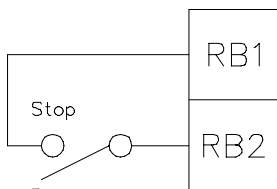

Figure 12. Regenerative Deceleration Switch Connection

## Regenerative brake

Short the INHIBIT terminals to regeneratively brake the motor. Reopening the INHIBIT terminals causes the motor to accelerate to set speed.

The INHIBIT terminals bypass both the MIN SPD circuit and the deceleration circuit. This causes the motor to stop rapidly when the INHIBIT terminals are shorted. Braking torque is determined by the opposite-direction torque setting.

Minarik Corporation offers two accessory plug harnesses for the INHIBIT terminals:

Minarik<sup>®</sup>

Part Number	Description
201-0024	Inhibit plug with 18 in. (46 cm) wires
201-0079	Inhibit plug with 36 in. (91 cm) wires

Always twist inhibit wires and separate them from other power-carrying wires or sources of electrical noise. Use shielded cable if the inhibit wires are longer than 18 inches (46 cm). If shielded cable is used, ground only one end of the shield to earth ground. **Do not ground both ends of the shield.**

## Decelerate to minimum speed

The circuit shown in Figure 13 may be used to decelerate a motor to a minimum speed. Closing the switch between S2 and S0 decelerates the motor from set speed to a minimum speed determined by the MIN SPD trimpot setting. If the MIN SPD trimpot is set full CCW, the motor decelerates to zero speed when the switch between S2 and S0 is closed. The applied direction ACCEL trimpot (FWD or REV) setting determines the rate at which the drive decelerates. Set the switch to the RUN position to accelerate the motor to set speed at a rate determined by the applied direction ACCEL trimpot setting.

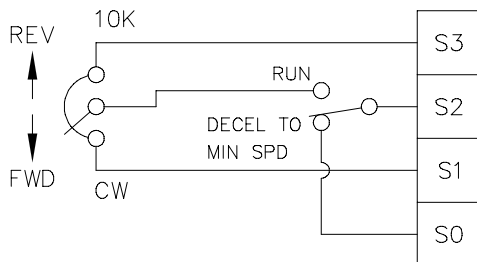

Figure 13. Run/Decelerate to Minimum Speed Switch (shown with bidirectional speed adjust potentiometer connection)



## **⚠ Warning**

For frequent starts and stops, use regenerative deceleration (shorting RB1 and RB2), regenerative braking (shorting INHIBIT terminals to each other), or decelerating to minimum speed (shorting S2 to S0). Do not use any of these methods for emergency stopping. They may not stop a drive that is malfunctioning. **Removing AC line power (both L1 and L2) is the only acceptable method for emergency stopping.**

INHIBIT is part of the speed reference circuit. When engaged, other functions, such as IR COMP, FWD TQ and REV TQ may still be active.

Frequent regenerative deceleration, regenerative braking, coasting to a stop, or decelerating to minimum speed produces high torque. This may cause damage to motors, especially gearmotors that are not properly sized for the application. When sizing gearmotors with regenerative drives, check the gearbox torque rating is not exceeded.

## Calibration

Each drive is factory calibrated to its maximum horsepower rating. Readjust the calibration trimpot settings to accommodate lower horsepower motors.

All adjustments increase with CW rotation, and decrease with CCW rotation. Use a non-metallic screwdriver for calibration. Each trimpot is identified on the printed circuit board.

### MIN SPD

The MIN SPD setting determines the minimum speed when the speed adjust potentiometer is turned full CCW. It is factory set to zero speed. **The minimum speed feature applies only when the drive is operating in unidirectional mode.**

To calibrate MIN SPD:

1. Set the speed adjust potentiometer full CCW.
2. Adjust the MIN SPD trimpot until the motor turns at the desired minimum speed.

### MAX SPD

The MAX SPD setting determines the maximum motor speed when the speed adjust potentiometer is turned full CW. It is factory set for maximum rated motor speed.

To calibrate MAX SPD:

1. Set the MAX trimpot full CCW.
2. Turn the speed adjust potentiometer full CW.
3. Adjust the MAX SPD trimpot until the desired maximum motor speed is reached.

## **FWD TQ**

The FWD TQ setting determines the maximum torque for accelerating and driving the motor in the forward direction. It also sets the maximum torque for decelerating the motor in the reverse direction. FWD TQ is factory set at 120% of rated motor current.

To calibrate FWD TQ:

1. With the power disconnected from the drive, connect a DC ammeter in series with the armature.
2. Set the FWD TQ trimpot to minimum (full CCW).
3. Connect power to the drive.
4. Lock the motor shaft. Be sure that the motor is firmly mounted.
5. Set the speed adjust potentiometer for maximum forward speed .
6. Adjust the FWD TQ trimpot CW slowly until the armature current is 120% of motor rated armature current.
7. Set the speed adjust potentiometer to minimum and remove the stall from the motor.

## REV TQ

The REV TQ setting determines the maximum torque for accelerating and driving the motor in the reverse direction. It also sets the maximum torque for decelerating in the forward direction. REV TQ is factory set at 120% of rated motor current.

To calibrate REV TQ:

1. With the power disconnected from the drive, connect a DC ammeter in series with the armature.
2. Set the REV TQ trimpot to minimum (full CCW).
3. Connect power to the drive.
4. Lock the motor shaft. Be sure that the motor is firmly mounted.
5. Set the speed adjust potentiometer to maximum reverse speed.
6. Adjust the REV TQ trimpot CW slowly until the armature current is 120% of motor rated armature current.
7. Set the speed adjust potentiometer to minimum and remove the stall from the motor.

## IR COMP

The IR COMP trimpot setting determines the degree to which motor speed is held constant as the motor load changes. It is factory set for optimum motor regulation. To calibrate IR COMP (exact calibration):

1. Turn the IR COMP trimpot full CCW.
2. Set the speed adjust potentiometer until the motor runs at midspeed without load (for example, 900 RPM for an 1800 RPM motor) A hand held tachometer may be used to measure motor speed.
3. Load the motor armature to its full load armature current rating. The motor should slow down.
4. While keeping the load on the motor, rotate the IR COMP trimpot until the motor runs at the speed measured in step 2.

### *Approximate calibration:*

If the motor does not maintain set speed as the load changes, gradually rotate the IR COMP trimpot CW. If the motor oscillates (overcompensation), the IR COMP trimpot may be set too high (CW). Turn the IR COMP trimpot CCW to stabilize the motor speed.

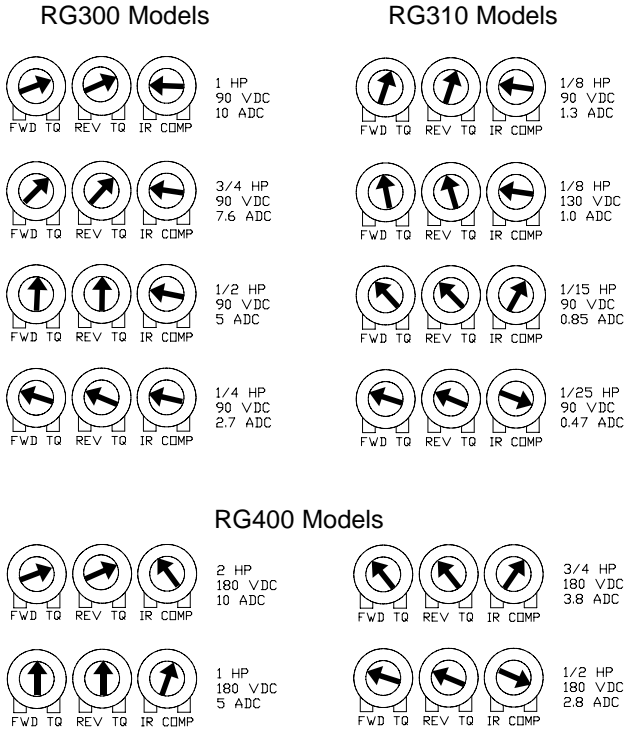

Figure 14. Typical FWD TQ, REV TQ, and IR COMP Settings  
(actual settings may vary with each application)

## **FWD ACC**

The FWD ACC setting determines the time the motor takes to ramp to either a higher speed in the forward direction or a lower speed in the reverse direction, within the limits of available torque. The FWD ACC setting is factory set for its fastest forward acceleration time.

Turn the FWD ACC trimpot CW to increase the forward acceleration time, and CCW to decrease the forward acceleration time.

## **REV ACC**

The REV ACC setting determines the time the motor takes to ramp to either a higher speed in the reverse direction or a lower speed in the forward direction, within the limits of available torque. The REV ACC setting is factory set for its fastest reverse acceleration time.

Turn the REV ACC trimpot CW to increase the reverse acceleration time, and CCW to decrease the reverse acceleration time.

## DB

The deadband trimmer potentiometer determines the time that will elapse between the application of current in one direction before current is applied in the opposite direction.

The deadband trimmer potentiometer affects the resistance that a motor has to changes in shaft position at zero speed. It does this by applying AC voltage to the motor armature.

Deadband is factory calibrated to approximately the 3 o'clock position for 60 Hz AC line operation. Recalibrate the deadband to the 9 o'clock position for 50 Hz AC line operation. See Figure 15 for deadband settings.

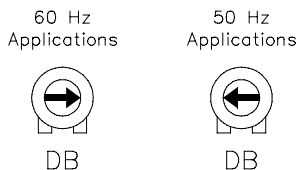

Figure 15. Deadband Settings



# Application Notes

## Connection to other Minarik devices

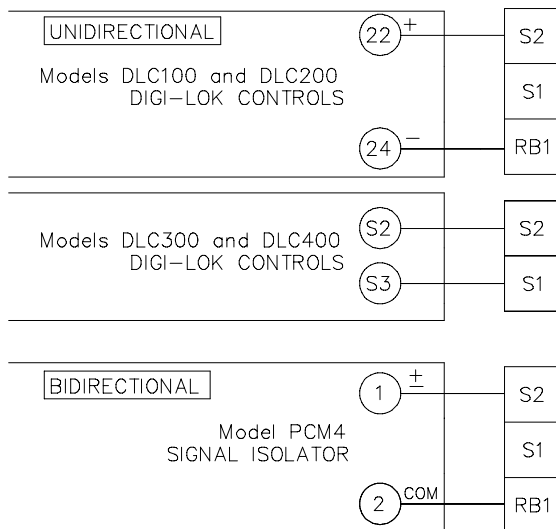

Figure 16. RG300/RG400 Series Connection to DLC100(DLC200), DLC300(DLC400), and PCM4

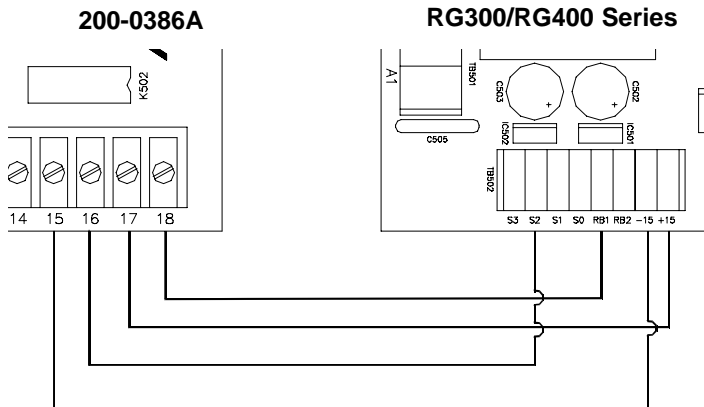

Figure 17. RG300/RG400 Series connection to 200-0386A Limit Switch Logic Board

## Optional speed adjust potentiometer connections

Use a single pole, two position switch with a single speed adjust potentiometer to plug reverse the motor (Figure 18). The MIN SPD setting is in effect for either direction.

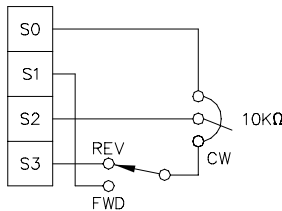

Figure 18. Forward-Reverse Switch

Use a single pole, three position switch with a single speed adjust potentiometer to stop a motor between reversals (Figure 19). Set the switch to the center position to decelerate the motor to a stop.

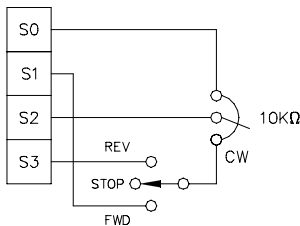

Figure 19. Forward-Stop-Reverse Switch

Connect two speed adjust potentiometers with a single pole two position switch to select between two independent speeds shown in the forward direction (Figure 20). The speed adjust potentiometers can be mounted at two separate operating stations.

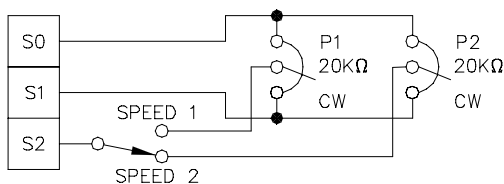

Figure 20. Independent Adjustable Speeds (Forward Direction)

Connect two speed adjust potentiometers as shown in Figure 21 to select between independent forward and reverse speeds.

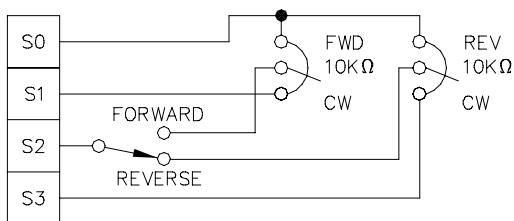

Figure 21. Independent Forward and Reverse Speeds

Use a single pole, three position switch to stop the motor when the switch is in the center position (Figure 22).

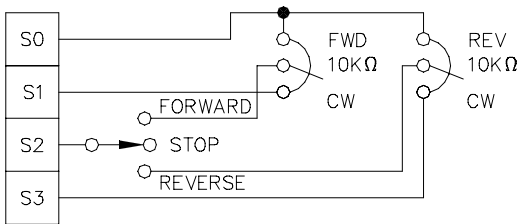

Figure 22. Independent Forward and Reverse Speeds with a Forward-Stop-Reverse Switch

# Troubleshooting

## **Warning**

Dangerous voltages exist on the drive when it is powered. When possible, disconnect the drive while troubleshooting. High voltages can cause serious or fatal injury.

Check the following steps before proceeding:

1. The AC line voltage must be balanced, and match the voltage on the drive nameplate.
2. The deadband (DB) must be set approximately at the 3 o'clock position for 60 Hz AC line frequency or at 9 o'clock for 50 Hz AC line frequency.
3. The motor must be rated for the drive's rated armature (all motors) and field outputs (shunt wound motors only).
4. Do not make any connections to F1 and F2 if using a permanent magnet motor.
5. Terminal block connections should be consistent with the connections shown in this manual.
6. Check that line fuse FU501 (and FU502 for 230 VAC line voltage) is properly sized and not blown.
7. Check that field fuse FU503 is 1.5 A and not blown.

<b>Problem</b>	<b>Possible Causes</b>	<b>Suggested Solutions</b>
Field fuse blows	<ol style="list-style-type: none"> <li>1. Field fuse is the wrong size</li> <li>2. Motor field is shorted to ground</li> <li>3. F1 is shorted to F2</li> <li>4. Motor cable is shorted to ground</li> <li>5. Motor field leads are reversed with motor armature leads.</li> </ol>	<ol style="list-style-type: none"> <li>1. Verify that the fuse is 1.5 A.</li> <li>2. Check if the motor field is shorted to ground. Replace motor if necessary.</li> <li>3. Check that F1 and F2 are not shorted together.</li> <li>4. Check that the motor cable is not shorted to ground. Replace cable if necessary.</li> <li>5. Wire motor armature to A1 and A2; wire motor field to F1 and F2.</li> </ol>
Line fuse blows	<ol style="list-style-type: none"> <li>1. Line fuse is the wrong size.</li> <li>2. Motor cable or armature is shorted to ground.</li> <li>3. Nuisance tripping caused by a combination of ambient conditions and high-current spikes (i.e. reversing).</li> </ol>	<ol style="list-style-type: none"> <li>1. Check that the line fuses are correct for the motor size (page 22).</li> <li>2. Check motor cable and armature for shorts.</li> <li>3. Add a blower to cool the drive components; decrease FWD TQ and REV TQ settings, <b>or</b> resize motor and drive for actual load demand, <b>or</b> check for incorrectly aligned mechanical components or “jams”.</li> </ol>

<b>Problem</b>	<b>Possible Causes</b>	<b>Suggested Solutions</b>
Line fuse does not blow, but the motor does not run.	<ol style="list-style-type: none"><li>1. Speed adjust potentiometer or voltage input signal set to zero speed.</li><li>2. Speed adjust potentiometer or voltage input signal not connected to drive input properly; connections are open.</li><li>3. REGEN BRAKE (INHIBIT terminals) is jumpered.</li><li>4. S2 is shorted to S1.</li><li>5. Drive is in current limit.</li><li>6. Drive is not receiving AC line voltage.</li><li>7. Motor is not connected.</li></ol>	<ol style="list-style-type: none"><li>1. Increase the speed adjust potentiometer or voltage setting.</li><li>2. Check connections to input. Verify that connections are not open.</li><li>3. Remove jumper from the INHIBIT terminals.</li><li>4. Remove short.</li><li>5. Verify that motor is not jammed. Increase FWD TQ or REV TQ setting, they are set too low.</li><li>6. Apply AC line voltage to L1 and L2.</li><li>7. Connect motor to A1 and A2.</li></ol>



<b>Problem</b>	<b>Possible Causes</b>	<b>Suggested Solutions</b>
Motor runs too slow or too fast.	<ol style="list-style-type: none"><li>1. MIN SPD and MAX SPD not calibrated.</li><li>2. Field not operating properly.</li></ol>	<ol style="list-style-type: none"><li>1. Calibrate MIN SPD and MAX SPD.</li><li>2. Verify motor field connections and voltage (see page 19).</li></ol>
Motor will not reach the desired speed.	<ol style="list-style-type: none"><li>1. MAX SPD setting is too low.</li><li>2. IR COMP setting is too low.</li><li>3. Motor is overloaded.</li></ol>	<ol style="list-style-type: none"><li>1. Increase MAX SPD setting.</li><li>2. Increase IR COMP setting.</li><li>3. Check motor load. Resize the motor if necessary.</li></ol>
Motor pulsates or surges under load.	<ol style="list-style-type: none"><li>1. IR COMP is set too high.</li><li>2. Motor bouncing in and out of TORQUE limit.</li></ol>	<ol style="list-style-type: none"><li>1. Adjust the IR COMP setting slightly CCW until the motor speed stabilizes.</li><li>2. Make sure motor is not undersized for load; adjust FWD TQ and REV TQ trimpot CW.</li></ol>

---

<b>Problem</b>	<b>Possible Causes</b>	<b>Suggested Solutions</b>
Motor makes a humming or buzzing noise.	Deadband setting is too high.	Turn deadband (DB) trimpot CCW until the noise stops.

For additional assistance, contact your local Minarik® Distributor, or the factory direct: phone (818)502-1528; fax (818)502-0716.

# Block Diagram

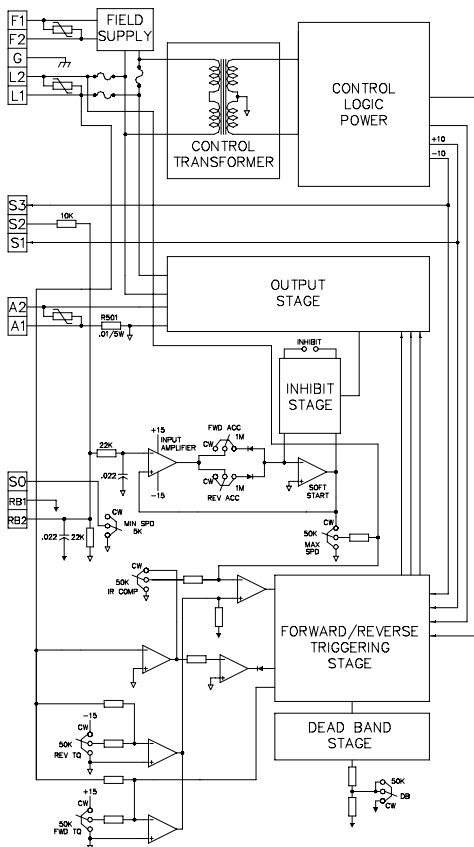

Figure 23. RG300 and RG400 Series Block Diagram

## Factory Prewired Connections (for Cased Drives)

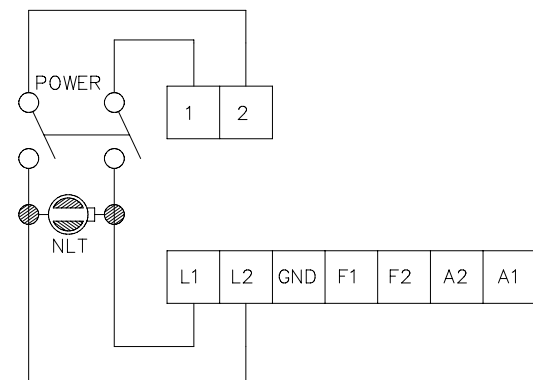

Figure 24. Prewired Connections to L1 and L2

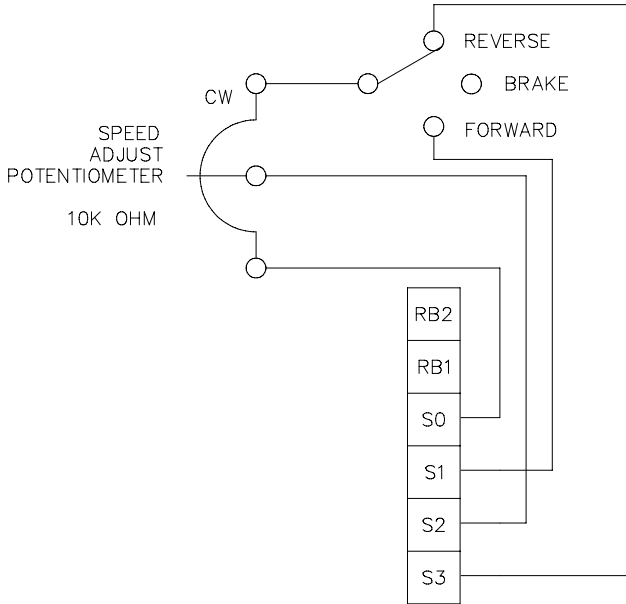

Figure 25. Prewired Speed Adjust Potentiometer Connections

## CE Compliance

Minarik Corporation hereby certifies that its RG300/RG400 series drives have been approved to bear the “CE” mark provided the conditions of approval have been met by the end user.

The RG300/RG400 series has been tested to the following test specifications:

**EN55011:1991 (emissions), and  
EN50082-1:1992 (immunity)**

Compliance allows Minarik’s RG300/RG400 series to bear the CE mark.

The end user, as described herein, falls into one of two categories:

1. The Consumer will deploy a stand-alone unit as an integral, yet external, portion of the machine being operated.
2. The Original Equipment Manufacturer (OEM) will implement the product as a component of the machine being manufactured.

In addition to EMI/RFI safeguards inherent in the RG300/RG400 series’ design, external filtering is required.

## Line filters

Minarik requires the Corcom<sup>®</sup> line filters listed in Table 3. If the exact filter is not available, the specifications are:

L = 0.88 milliHenries.

C = 0.30 microFarads (X); 0.011 microFarads (Y).

R = 680Kohms.

Rated current: 1.4 times maximum DC motor current.

Filter type: Balanced 2-section.

**Table 3. Corcom<sup>®</sup> Filters**

<b>Nameplate Current of Motor Wired to the Drive</b>	<b>Corcom<sup>®</sup> Filter Part Number</b>
0 to 4 amps	5VR1
4.1 to 13 amps	20VV1

The filters in Table 3 should be wired to the AC line within 0.25 meters of the drive. The ground connection from the filter must be wired to solid earth ground (resistance less than 500 ohms); not machine ground. This is very important!

If the end-user is using a CE-approved motor, the correct filter from Table 1 is all that is necessary to meet the EMC directives listed herein.

## Armature filters

If the end-user is not using a CE-approved motor, a CExxRG filter must be used on the armature. “XX” refers to the rated current of the filter.

The CE20RG is a Real-Pole Balanced-Pi 3-pole filter. If the exact filter is not available, the specifications are as follows:

$L \ \& \ L1 = 2 * (0.8)$  milliHenries.

$C \ \& \ C1 = 2 * (0.1)$  microFarads @ 400W VDC.

$R_{in} = 0.1$  ohm;  $R_{out} = 1.2$  ohm.

**Table 4. Minarik<sup>®</sup> Filters**

<b>Nameplate Current of Motor Wired to the Drive</b>	<b>Minarik<sup>®</sup> Filter Part Number</b>
0 to 4 amps	CE04RG
4.1 to 13 amps	CE20RG

The filters in Table 4 must be wired to the DC output of the drive, as close to the drive as possible.



The end user must use the filters listed in this section to comply with CE. The OEM may choose to provide alternative filtering that encompasses the Minarik drive and other electronics within the same panel.

The OEM has this liberty because CE is a machinery directive. Whether or not every component in the OEM's machinery meets CE, the OEM must still submit his machine for CE approval.

Thus, no component must necessarily meet CE within the machine, as long as the OEM takes the necessary steps to guarantee the machine does meet CE. By the same token, even if every component in the OEM's machine does meet CE, the machine will not necessarily meet CE as a machine.

Using CE-approved wiring practices (like proper shielding) and the filters listed in this section guarantee the drive will meet EN55011 (1991 emissions standard) and EN50082-1 (1992 immunity standard).

## Replacement Parts

Replacement parts are available from Minarik Corporation and its distributors for this drive series.

**Table 5. Replacement Parts**

<b>Model No.</b>	<b>Symbol</b>	<b>Description</b>	<b>Minarik® P/N</b>
<b>RG310UA</b>	R501	0.1Ω, 5 W Resistor	032-0100
	SCR501-508	800 V, 25 A SCR	072-0042
	T505	3FS-436 Transformer	230-0071
		10KΩ Potentiometer Kit	202-0003
		Chassis	223-0258
		8 A, 3AB Line Fuse	050-0023
		1.5 A, 3AG Field Fuse	050-0026
		Fuse Kit ( 3 – 8A)	050-0069
		Fuse Kit (5 – 20A)	050-0073
		Pico Fuse, 1/2 A	050-0064
<b>RG310A</b>	Same parts as RG310UA except 202-0003 and 223-0258. Include:		
	10KΩ, 2W Potentiometer	120-0047	
	Potentiometer Knob	140-0013	
	Case	223-0209	
	Green Neon Indicator	040-0043	
	FWD/BRAKE/REV Switch	080-0004	
	Power Switch	080-0022	
	Toggle Switch Boot	155-0050	
	Chassis	223-0260	
	Heat Sink	223-0232	
<b>RG310UA-S</b>	Same parts as RG310UA except		
	7-pin Terminal Block	160-0019	
	8-pin Terminal Block	160-0116	
<b>RG310A-S</b>	Same parts as RG310A except		
	7-pin Terminal Block	160-0019	
	8-pin Terminal Block	160-0116	

**Table 5. Replacement Parts (Continued)**

<b>Model No.</b>	<b>Symbol</b>	<b>Description</b>	<b>Minarik® P/N</b>
<b>RG300UA</b>	R501	0.01Ω, 5 W Resistor	032-0129
	SCR501-508	800 V, 25 A SCR	072-0042
	T505	3FS-436 Transformer	230-0071
		10KΩ Potentiometer Kit	202-0003
		Chassis	223-0258
		20 A, 3AB Line Fuse	050-0019
		1.5 A, 3AG Field Fuse	050-0026
		Fuse Kit (3 – 8A)	050-0069
		Fuse Kit (5 – 20A)	050-0073
		Pico Fuse, 1/2 A	050-0064
<b>RG300A</b>	Same parts as RG300UA except 202-0003 and 223-0258. Include:		
	10KΩ, 1/2 W Potentiometer	120-0032	
	Potentiometer Knob	140-0013	
	Case	223-0209	
	Green Neon Indicator	040-0043	
	FWD/BRAKE/REV Switch	080-0004	
	Power Switch	080-0022	
	Toggle Switch Boot	155-0050	
	Chassis	223-0260	
	Heat Sink	223-0232	
<b>RG300UA-S</b>	Same parts as RG300UA except		
	7-pin Terminal Block	160-0019	
	8-pin Terminal Block	160-0116	
<b>RG300A-S</b>	Same parts as RG300A except		
	7-pin Terminal Block	160-0019	
	8-pin Terminal Block	160-0116	

**Table 5. Replacement Parts (Continued)**

<b>Model No.</b>	<b>Symbol</b>	<b>Description</b>	<b>Minarik® P/N</b>
<b>RG400UA</b>	R501	0.1Ω, 5 W Resistor	032-0129
	SCR501-508	800 V, 25 A SCR	072-0042
	T505	3FD-436 Transformer	230-0072
		10KΩ Potentiometer Kit	202-0003
		Chassis	223-0258
		20 A, 3AB Line Fuse	050-0019
		1.5 A, 3AG Field Fuse	050-0026
		Fuse Kit ( 3 – 8A)	050-0069
		Fuse Kit (5 – 20A)	050-0073
		Pico Fuse, 1/2 A	050-0064
<b>RG400A</b>	Same parts as RG400UA except 202-0003 and 223-0258. Include:		
	10KΩ, 2 W Potentiometer	120-0047	
	Potentiometer Knob	140-0013	
	Case	223-0209	
	Green Neon Indicator	040-0005	
	FWD/BRAKE/REV Switch	080-0043	
	Power Switch	080-0022	
	Toggle Switch Boot	155-0050	
	Chassis	223-0260	
	Heat Sink	223-0232	
<b>RG400UA-S</b>	Same parts as RG400UA except		
	7-pin Terminal Block	160-0019	
	8-pin Terminal Block	160-0116	
<b>RG400A-S</b>	Same parts as RG400A except		
	7-pin Terminal Block	160-0019	
	8-pin Terminal Block	160-0116	

## **Notes**

## **Notes**

---

## Limited Warranty

**A. Warranty** - Minarik Corporation (referred to as "the Corporation") warrants that its products will be free from defects in workmanship and material for two (2) years from date of shipment thereof, or 6,000 hours, whichever comes first. Within this warranty period, the Corporation will repair or replace such products that are: (1) returned to Minarik Corporation, 901 East Thompson Avenue, Glendale, CA 91201-2011 USA; and, (2) determined by the Corporation to be defective.

This warranty shall not apply to any product that has been subject to misuse, negligence, or accident; or misapplied; or repaired by unauthorized persons; or improperly installed. The Corporation is not responsible for removal, installation, or any other incidental expenses incurred in shipping the product to and from the repair point.

**B. Disclaimer** - The provisions of Paragraph A are the Corporation's sole obligation and exclude all other warranties of merchantability for use, express or implied. The Corporation further disclaims any responsibility whatsoever to the customer or to any other person for injury to the person or damage or loss of property of value caused by any product that has been subject to misuse, negligence, or accident, or misapplied or modified by unauthorized persons or improperly installed.

**C. Limitations of Liability** - In the event of any claim for breach of any of the Corporation's obligations, whether express or implied, and particularly of any other claim or breach of warranty contained in Paragraph A, or of any other warranties, express or implied, or claim of liability that might, despite Paragraph B, be decided against the Corporation by lawful authority, the Corporation shall under no circumstances be liable for any consequential damages, losses, or expense arising in connection with the use of, or inability to use, the Corporation's product for any purpose whatsoever.

An adjustment made under warranty does not void the warranty, nor does it imply an extension of the original two (2) year or 6,000 hour warranty period. Products serviced and/or parts replaced on a no-charge basis during the warranty period carry the unexpired portion of the original warranty only.

If for any reason any of the foregoing provisions shall be ineffective, the Corporation's liability for damages arising out of its manufacture or sale of equipment, or use thereof, whether such liability is based on warranty, contract, negligence, strict liability in tort, or otherwise, shall not in any event exceed the full purchase price of such equipment.

Any action against the Corporation based upon any liability or obligation arising hereunder or under any law applicable to the sale of equipment or the use thereof, must be commenced within one year after the cause of such action arises.



901 East Thompson Avenue  
Glendale, California 91201-2011

Phone: (818) 502-1528

Fax: (818) 502-0716

[www.minarikcorp.com](http://www.minarikcorp.com)

Document number 250-0167, Revision 2

Printed in the U.S.A – 2/98

North America \$12.00, Outside North America \$15.00