

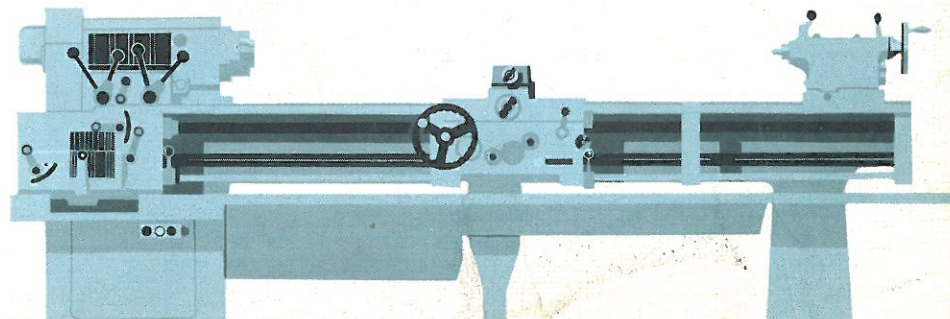

Monarch  series K lathes

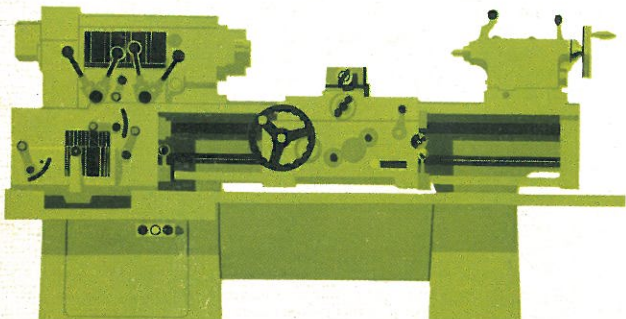

Monarch Series K. Low in cost . . . but high in accuracy and productivity. Versatile . . . but dependable, easy to maintain and operate. Why tolerate worn out or inadequately designed equipment? You can buy a Series K for little more than the cost of a good used lathe. Monarch Series K lathes are designed for more economical production of accurate work. Behind every feature is a history of successful field performance. Which of the three models is best suited for **your** shop?

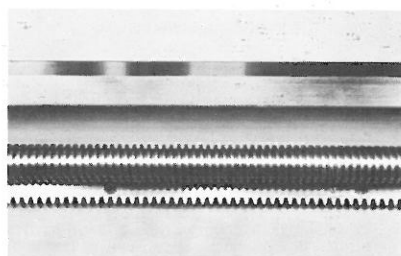
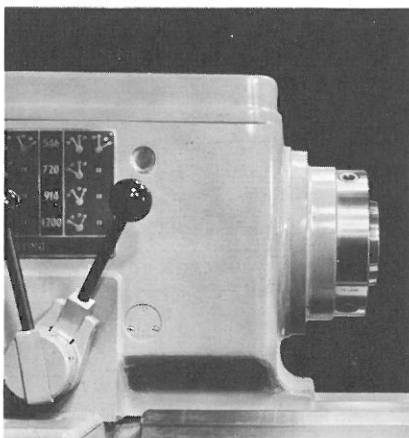
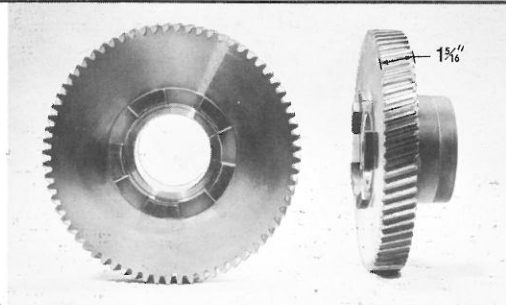
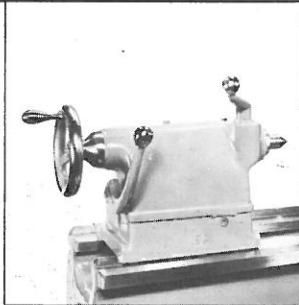
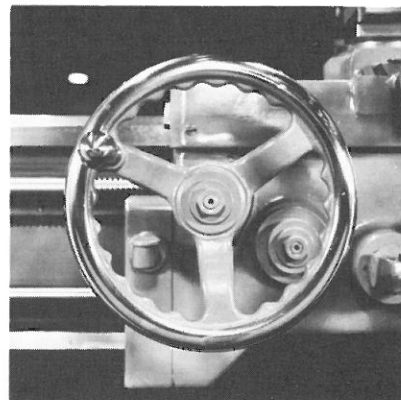
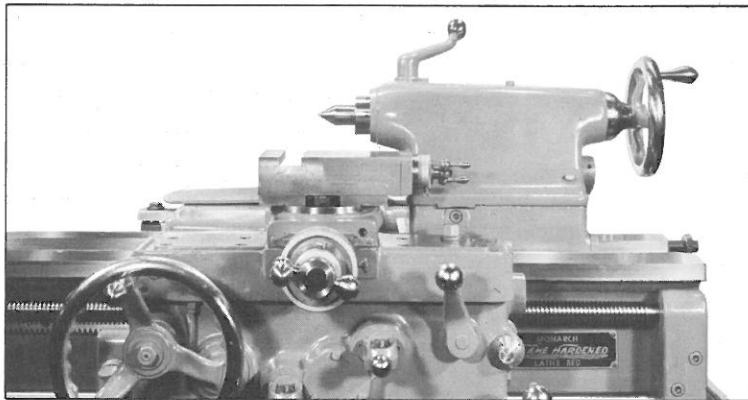
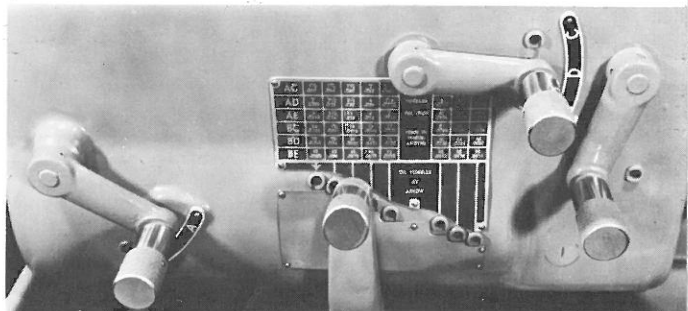
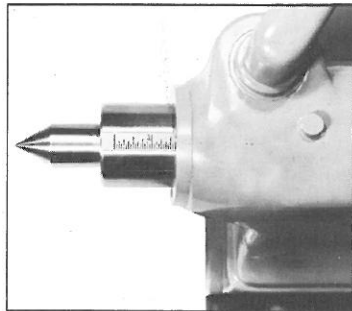

K

13x30 16x54
16x78 18x54 18x78

Complete in every sense of the word, these high capacity, low cost, solidly built lathes are field-proven to be a profit-making addition to any size shop.

For little more than you would pay for a good used lathe, a Model K has most of the features you expect only on lathes costing much more. Here is Monarch's answer to your search for economy . . . but reliability, capacity and accuracy, too.

Which of these three models, five sizes, is the right one for your shop? Ask for a demonstration and quotation of price (low) and delivery (fast).

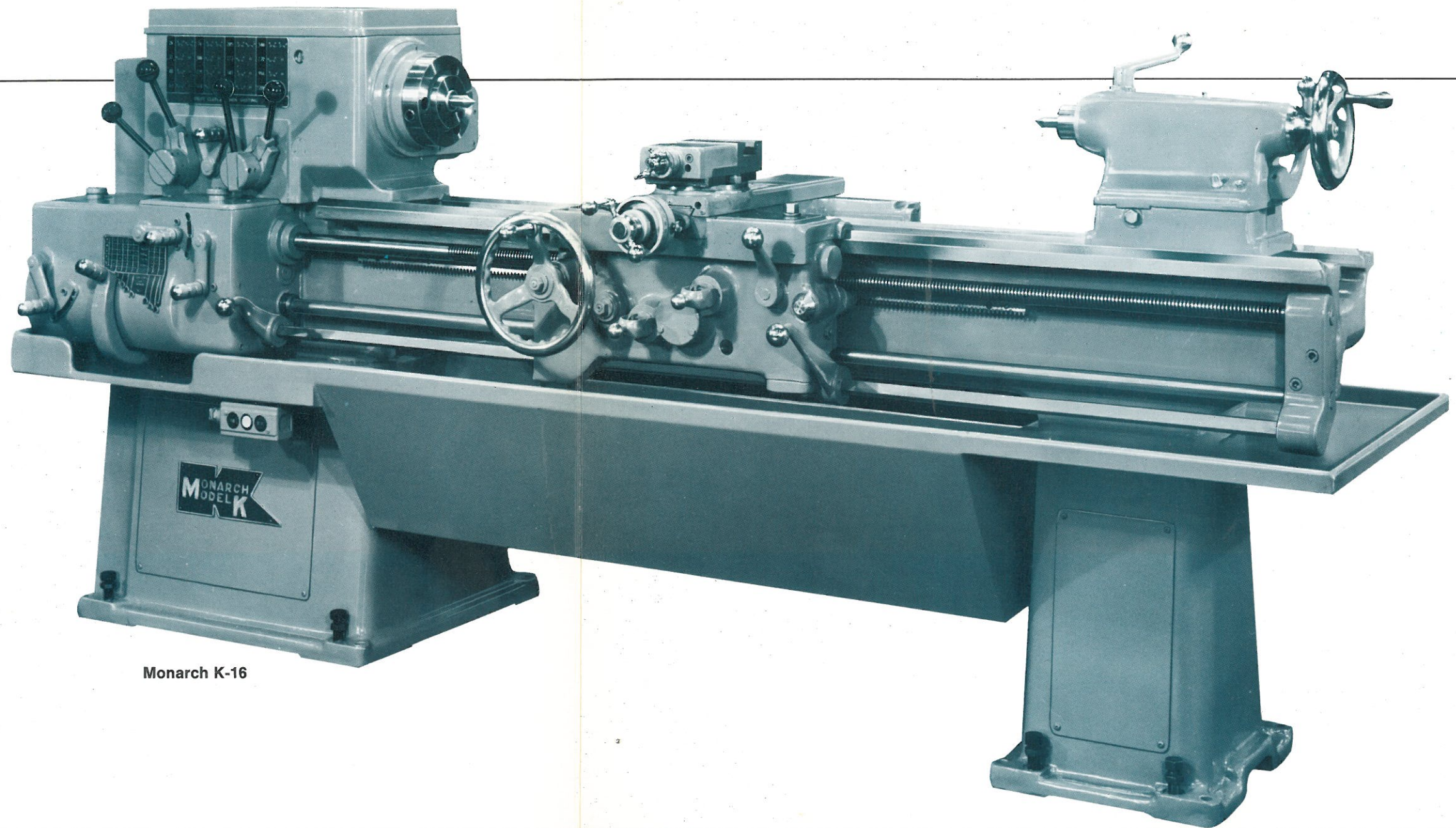

Monarch K-16

All Series K lathes have a massive gear train, with 16 speeds from 28 to 1200 rpm. Heat treated, precision-finished helical gears transmit positive power rapidly, smoothly, quietly . . . now and for years to come. The rigid, through hardened spindle, with its ASA 6" D-1 cam lock spindle nose, rotates on three precision bearings. You can mount chucks, face plates, dog plates and fixtures quickly, rigidly, accurately and close as possible to the front spindle bearings. Overhang is cut to a minimum. No threads to clean, just wipe off the locating taper.

All shafts turn freely on anti-friction bearings. Heavy, hardened, positive jaw clutches are operated by levers to make safe effortless speed changes. A multiple disc type brake makes fast, sure stops. Thread and feed reversing mechanism is enclosed.

Proper lubrication of a Monarch K lathe is not dependent on the operator's memory. Automatic lubrication, through a combined pump and splash system, provides metered pressure to bearings. Proper function of this automatic lubrication can be checked by visual gauge.

Headstock

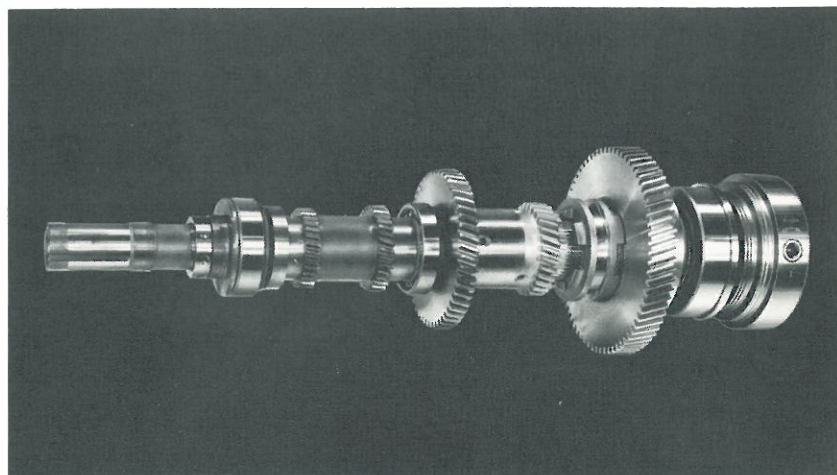

Bed The heavily ribbed bed, designed for strength plus easy chip clearance, is cast from alloyed iron. All four bed ways (not just the carriage ways) are flame-hardened to a depth of more than 1/8-inch for a Scleroscope reading of 70 to 72 Shore. The hardened surface area of the ways blends into a tough, resilient cast iron underbody for unequalled vibration dampening and greatest resistance to wear.

The Monarch K has a one-piece bed, ground to an overall tolerance of .0005 inch. There are no replaceable ways to go out of alignment. Leveling screws are provided for each leg.

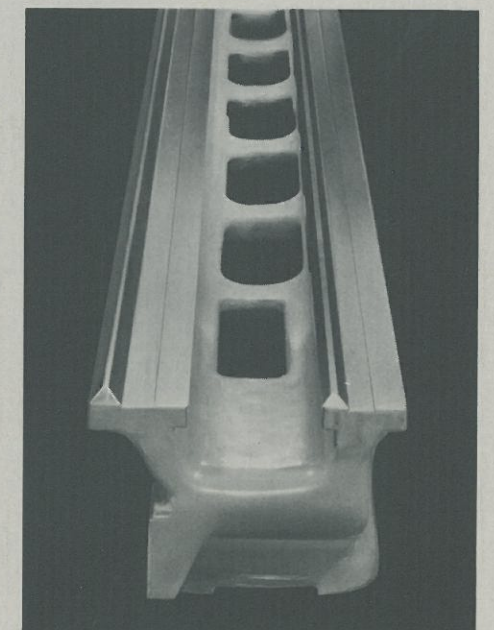

K

13x30 16x54
16x78 18x54 18x78

Complete in every sense of the word, these high capacity, low cost, solidly built lathes are field-proven to be a profit-making addition to any size shop.

For little more than you would pay for a good used lathe, a Model K has most of the features you expect only on lathes costing much more. Here is Monarch's answer to your search for economy . . . but reliability, capacity and accuracy, too.

Which of these three models, five sizes, is the right one for your shop? Ask for a demonstration and quotation of price (low) and delivery (fast).

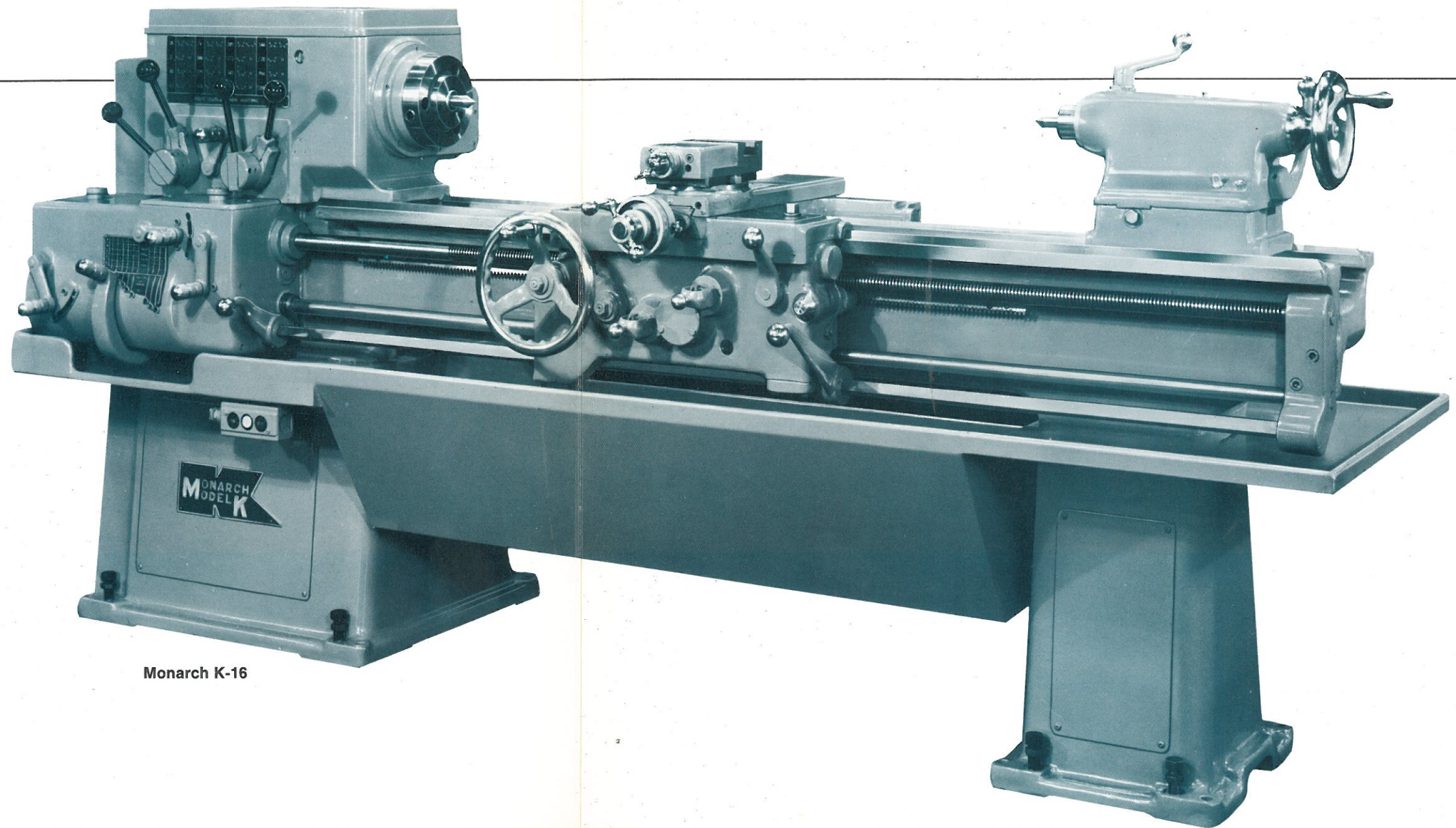

Monarch K-16

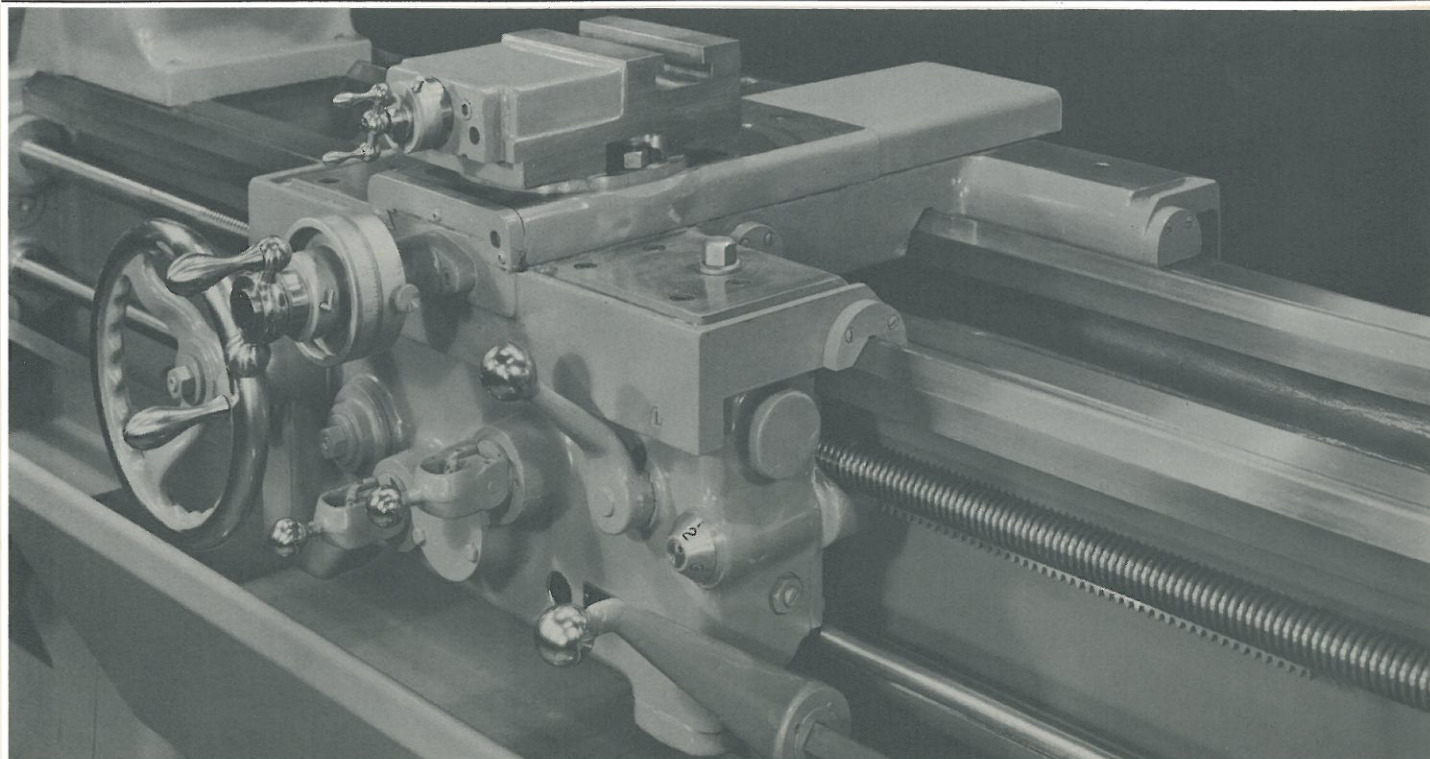

Apron

No bevel gear drive here. Power is transmitted to the apron smoothly and uniformly by worm drive. Two independent levers control longitudinal and cross feeds through large, cone-type friction clutches.

The precision leadscrew is mounted in anti-friction thrust bearings. To preserve leadscrew accuracy for threading, no contact is made with the leadscrew when using the feed rod for feeding.

Check the important operator convenience features of a K. Try them yourself, including the apron-mounted remote spindle control. Notice how the smooth, highly polished apron and cross feed handles give you sensitive control in positioning the cutting tool. Test the palm-of-the-hand size knobs on the headstock levers for quick, positive shifting. Grasp the knurled knobs on the gear box levers, where a sure grip is needed. And you'll find all these controls where you would most naturally reach for them.

Metered oil is supplied automatically to all moving parts of the apron, to the carriage bearing on the bed and to the compound rest bottom slide bearing on the carriage.

Carriage, Cross Slide and Compound

To provide the best possible wear surfaces, these parts are made of especially high-quality cast iron having a Brinell hardness of 190 to 230. Extra heavy slides provide maximum tool support. Precision cross feed and compound screws provide long maintenance of original accuracy. Cross feed screw is anchored in anti-friction thrust bearings.

Large, satin finish dials are graduated in thousandths for easy, accurate reading. The compound rotates through 360° with an accurately graduated swivel. When chasing threads, the cross feed chasing stop permits quick tool withdrawal and repositioning to the last depth of cut. Design of the Monarch K permits clearance to use the compound parallel to the tailstock spindle center.

K

13x30 16x54
16x78 18x54 18x78

Complete in every sense of the word, these high capacity, low cost, solidly built lathes are field-proven to be a profit-making addition to any size shop.

For little more than you would pay for a good used lathe, a Model K has most of the features you expect only on lathes costing much more. Here is Monarch's answer to your search for economy... but reliability, capacity and accuracy, too.

Which of these three models, five sizes, is the right one for your shop? Ask for a demonstration and quotation of price (low) and delivery (fast).

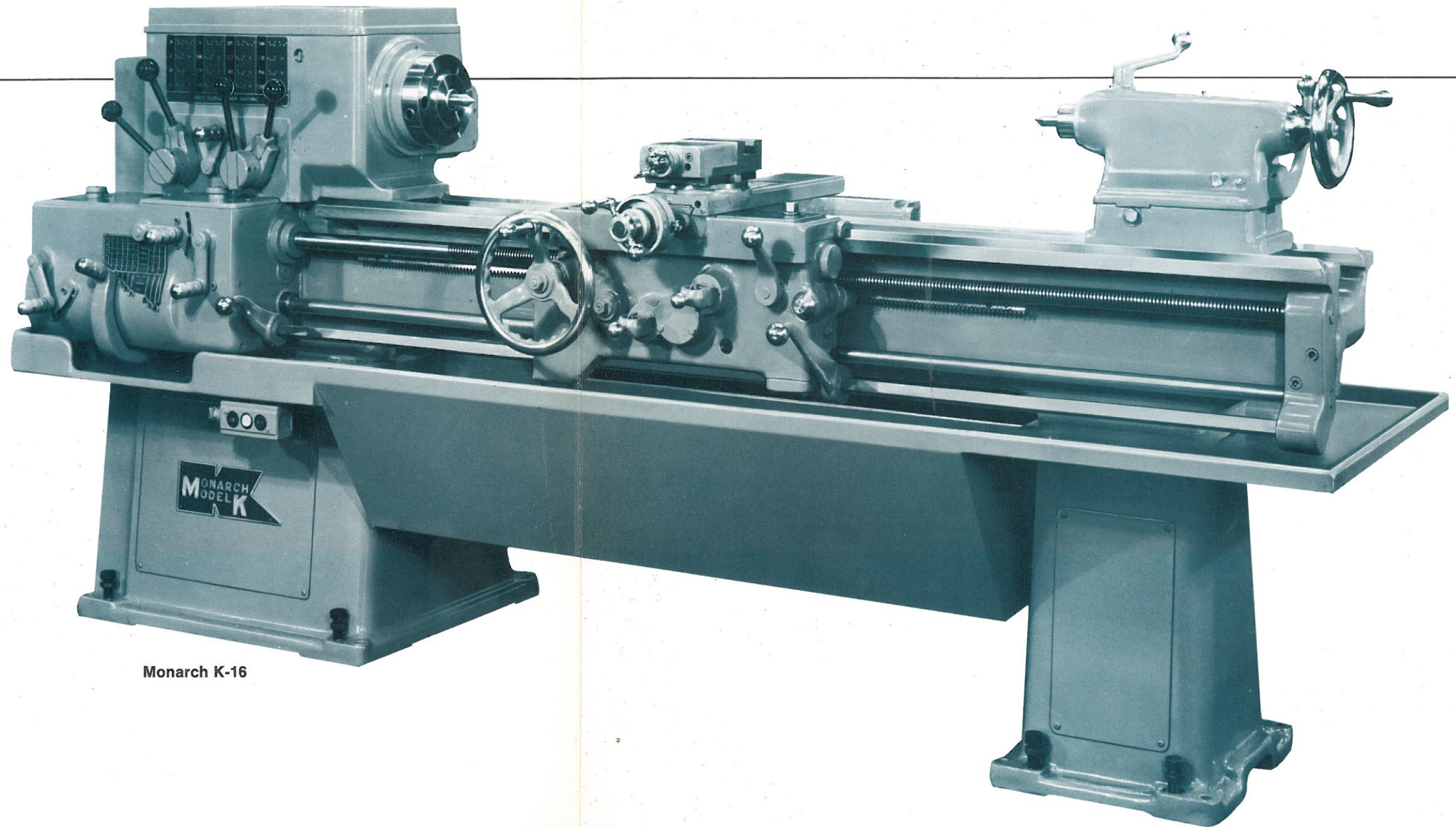

Monarch K-16

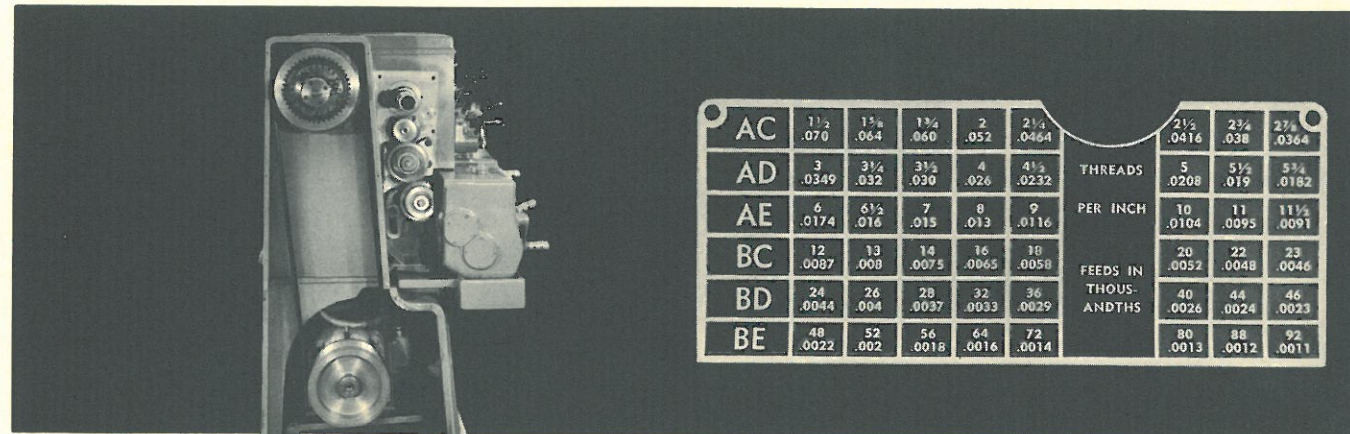

Main Drive

Located inside the cabinet leg, the main drive motor is mounted on a hinged plate that maintains proper driving belt tension on the balanced multiple v-belts. The plate type clutch and multiple disc brake are controlled by levers convenient to the operator: one close to the headstock, one at the apron. These levers provide the sensitive operator control desirable for starting, braking and jogging the spindle.

Gear Box and End Gearing

All U. S. standard and fine threads are included in the 48-thread range. Feeds per revolution range from .0011 to .070 inches. The end gear train has a quadrant with an idler gear and sufficient adjustment to accept compound gearing for chasing odd leads. Gear box lubrication is centralized, while the gears in the end gear train are mounted on oil-seal type bearings.

Sturdily designed for solid work support, the heavy, screw operated tailstock is quickly and easily clamped to the bed by lever action. The Model K-18" tailstock shown right, has an auxiliary clamp for extra-heavy duty.

The hardened and ground tailstock spindle contains a dead center and drift slot for tool ejection. A graduated scale on the barrel facilitates drilling operations.

A reservoir in the tailstock base feeds oil to hardened and ground way surfaces. Lubrication for horizontal movement of the spindle is provided by oil cups on top of the tailstock. Wipers prevent chips and dirt getting under the tailstock to damage the bed ways.

Tailstock

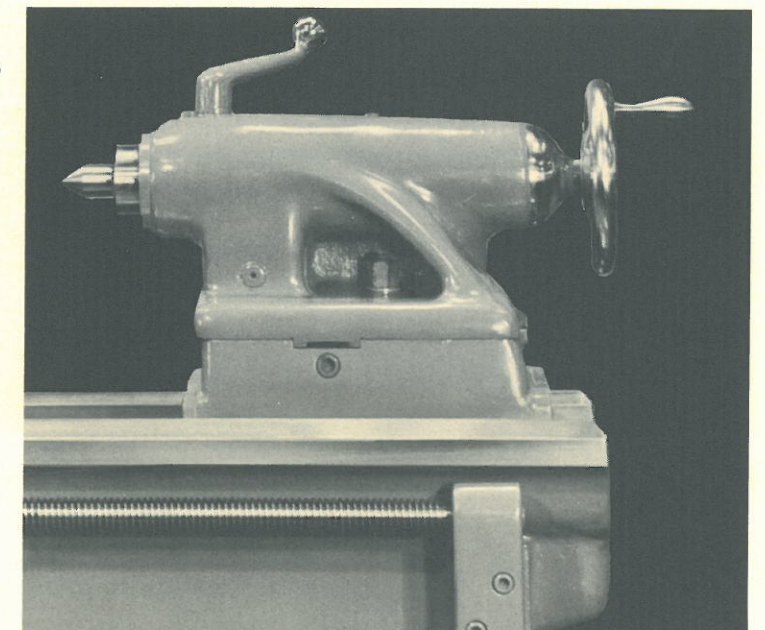

K

13x30 16x54
16x78 18x54 18x78

Complete in every sense of the word, these high capacity, low cost, solidly built lathes are field-proven to be a profit-making addition to any size shop.

For little more than you would pay for a good used lathe, a Model K has most of the features you expect only on lathes costing much more. Here is Monarch's answer to your search for economy . . . but reliability, capacity and accuracy, too.

Which of these three models, five sizes, is the right one for your shop? Ask for a demonstration and quotation of price (low) and delivery (fast).

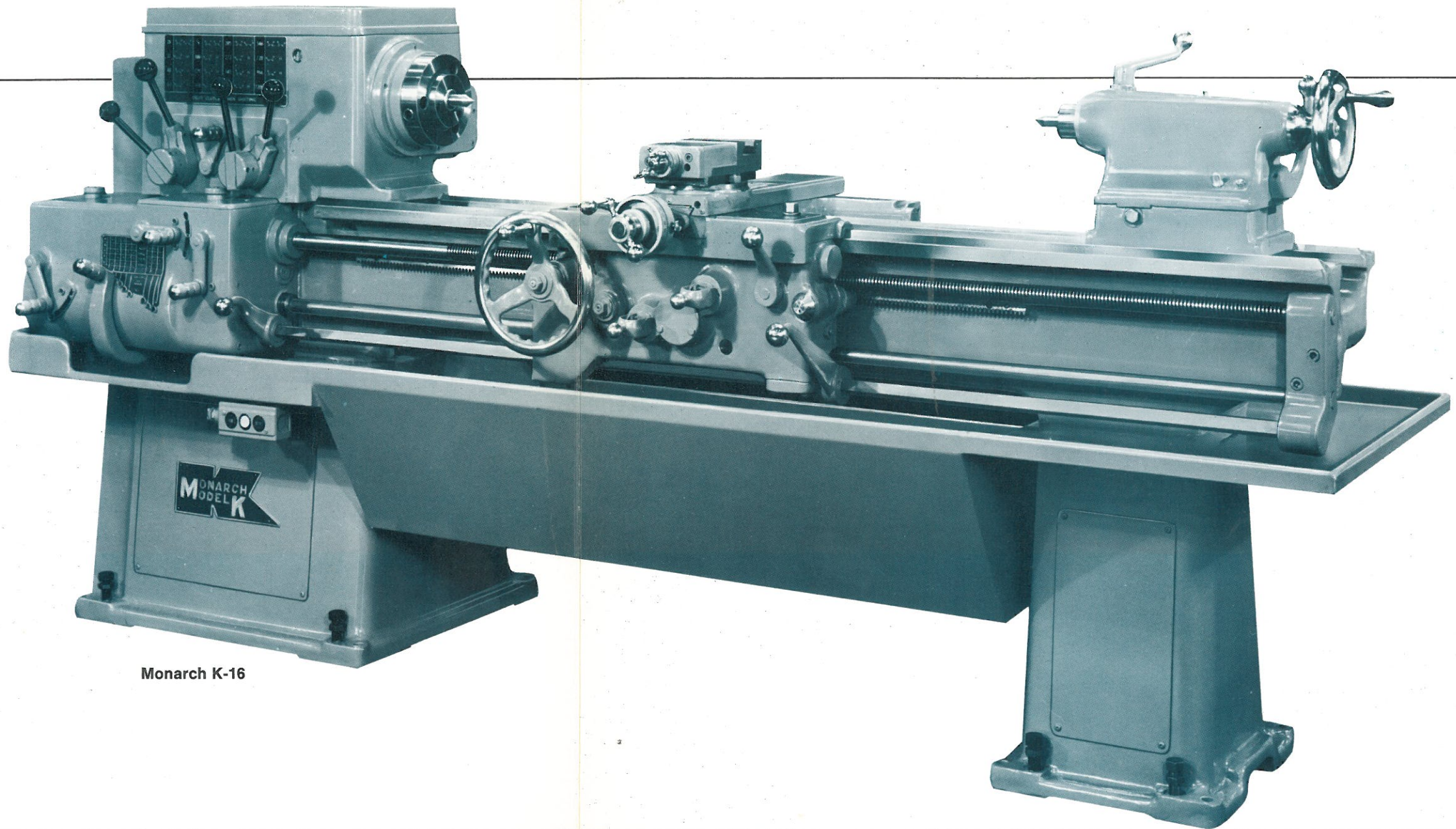

Monarch K-16

Accessory Equipment

Steady rest

Follow rest

Turret

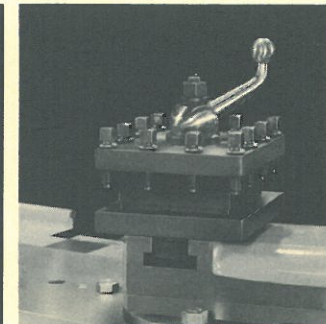
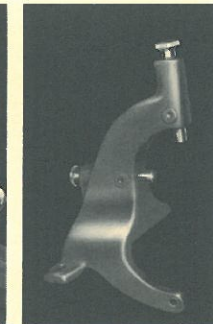
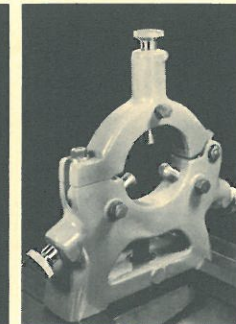
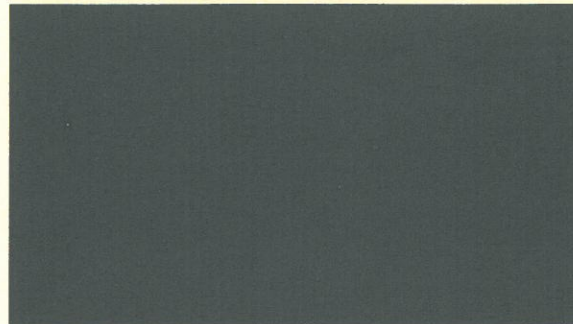

Renewable tip plain jaws. Hinged top, 1/2 to 4 1/2-inch capacity.

Plain renewable tip jaws. 1/2 to 3 1/2-inch capacity.

Indexes accurately to twelve positions and fits directly to compound. Model K-13"—4 1/2 inches square, 3/4 inch maximum tool height. Model K-16"—4 1/2 inches square, 1 inch maximum tool height. Model K-18"—6 1/2 inches square, 1 inch maximum tool height.

Round tool post
Heavy duty tool post

Dog plate
Face plate

Taper attachment

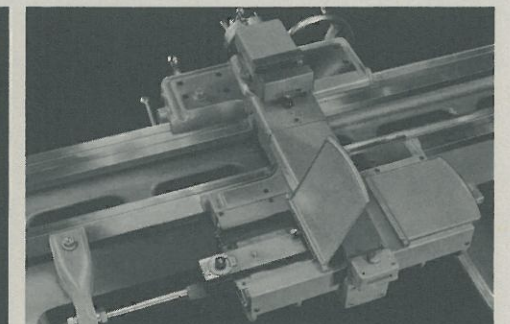
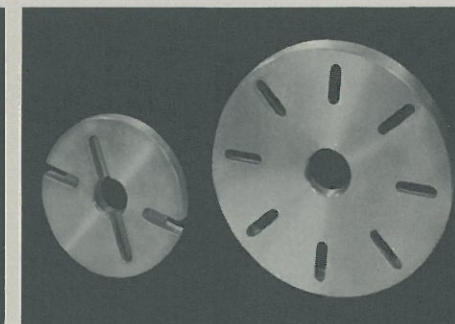
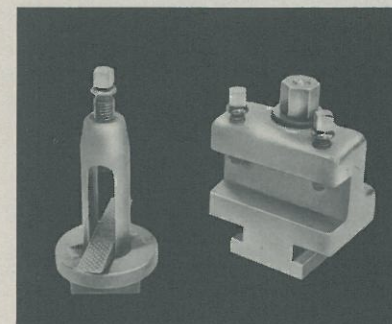

Standard equipment. Heat treated, with step ring and rocker.

Recommended for heavy stock removal. Maximum tool size is 1x1 inch on Models K-13" and K-16", 1 1/4 in. high x 1 in. wide on the Model K-18".

Standard equipment. 10" diameter for all three models. Dual slots for small and large dogs.

Has eight cored slots to facilitate attachment of fixtures. Models K-13" and K-16" use 13" diameter, Model K-18" uses 15" diameter.

Ball bearing anti-friction type. Permanent sealed-in lubrication. Practically eliminates lost motion, backlash, friction. Bearing surfaces flame hardened and ground. Vernier dial. Hinged slide covers. 4" maximum taper turning per foot, 18° maximum included angle, 12" maximum length at one setting.

K

13x30 16x54
16x78 18x54 18x78

Complete in every sense of the word, these high capacity, low cost, solidly built lathes are field-proven to be a profit-making addition to any size shop.

For little more than you would pay for a good used lathe, a Model K has most of the features you expect only on lathes costing much more. Here is Monarch's answer to your search for economy . . . but reliability, capacity and accuracy, too.

Which of these three models, five sizes, is the right one for your shop? Ask for a demonstration and quotation of price (low) and delivery (fast).

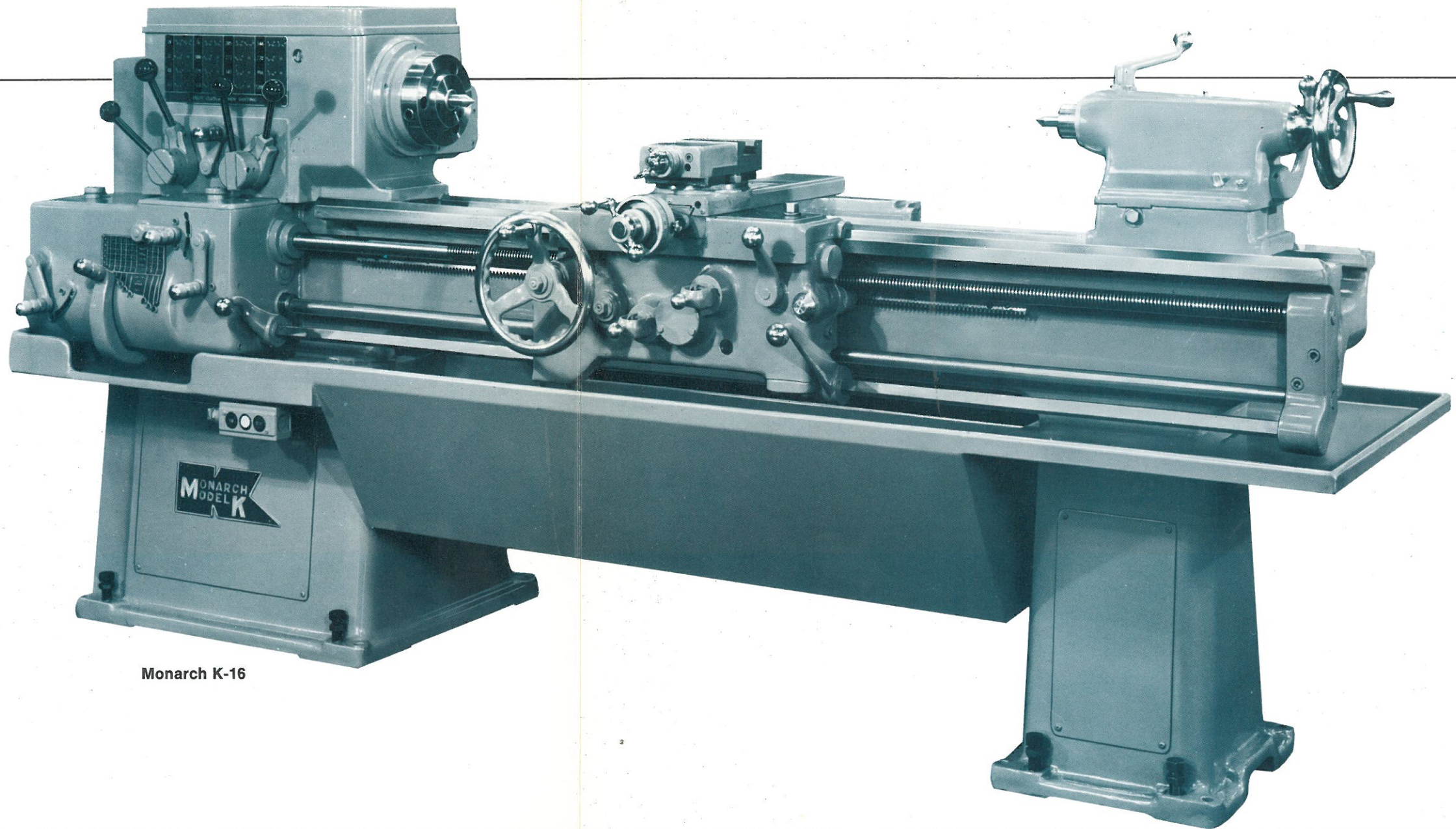

Monarch K-16

Micrometer carriage stop
Multiple positive carriage stop

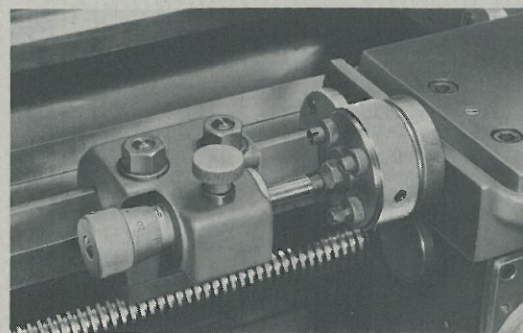

Stop bracket positioned at any point on front bed v and locked in place by means of two clamp screws. Tightening a knob located above it securely locks the barrel in position.

Indexing cylinder with four adjustable stop screws. Attached to the left carriage wing for use with micrometer stop.

Anti-friction center

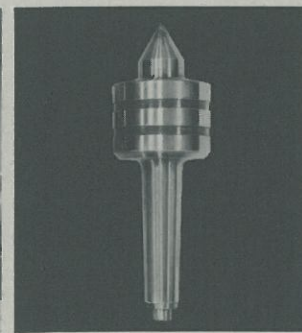

Fits tailstock for high speed turning.

Chip pan Generous size and designed for easy chip removal from rear of the lathe. Also serves as coolant pan.

Coolant system Driven by individual motor, coolant pump may be installed on new machines at the factory, or may be field applied providing lathe has chip pan.

Air-Tracer Pak The completely self contained Monarch Air-Tracer Pak can be used with any Series K lathe to provide tracer control without reduction of swing capacity.

Mechanical chucks Three-jaw universal type with steel body and two-piece reversible jaws having 10-inch capacity. Four-jaw independent type with steel body and reversible jaws having 12-inch capacity.

Sjogren collet chuck Fits directly on cam lock spindle nose. Maximum collet size, 1 3/8 inches.

Tool cabinet



Reinforced, welded steel; ample space for chucks, rests, plates, wrenches, collets. Turntables available for top compartment storage of collets. Hole sizes to match collets. With piano hinged top open, 10" x 22" space still available on top surface for operator's personal toolbox. Front panel between top surface and drawer is removable. Drawer is 4" deep, has 3 compartments, heavy duty spring catch. Replaceable 1/4" masonite protects top surface. Dimensions: 22" x 22" x 40". Weight, with turntable for collets: 136 lbs.

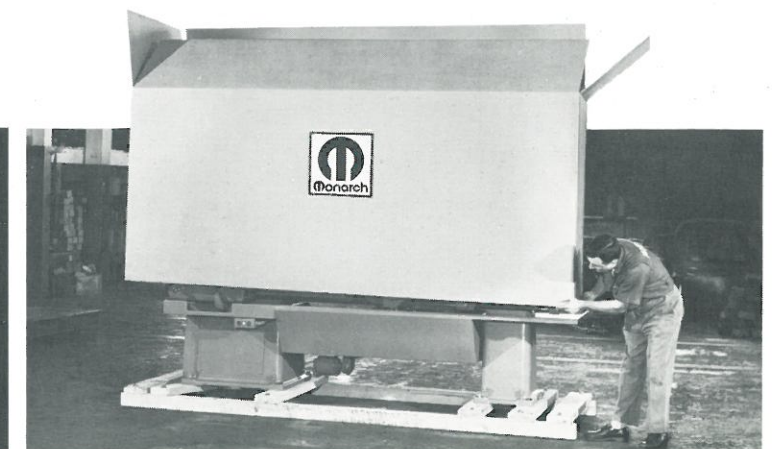

Your Series K lathe will be shipped in A-1 condition, ready for service. Securely bolted to a well constructed skid, the entire lathe will be enclosed in reinforced, triple-wall corrugated fibre-board. Since they are so well protected, parts subject to oxidation will be coated only with light grease. You will not have the difficulty of removing the protective coatings normally used when lathes are shipped exposed. Just wipe off your lathe, connect it to power and put it to work.

Specifications

	Model K-13	Model K-16		Model K-18	
	13" x 30"	16" x 54"	16" x 78"	18" x 54"	18" x 78"
Swing over bed and carriage wings	14"	16"	16"	18"	18"
Swing over cross slide	8 $\frac{1}{4}$ "	10"	10"	11"	11"
Distance between centers	30"	54"	78"	54"	78"
Floor space	40"x92"	40"x116"	40"x140"	42"x116"	42"x140"
Headstock					
Hole through spindle	1 $\frac{3}{32}$ "	1 $\frac{3}{32}$ "	1 $\frac{3}{32}$ "	1 $\frac{3}{32}$ "	1 $\frac{3}{32}$ "
Spindle bearings, tapered roller	Precision	Precision	Precision	Precision	Precision
Center, Morse taper	No. 3	No. 4	No. 4	No. 4	No. 4
Cam lock spindle nose	D-1-6"	D-1-6"	D-1-6"	D-1-6"	D-1-6"
Number of speeds	16	16	16	16	16
Spindle speed range, rpm	28, 37, 48, 63, 76, 100, 129, 168, 205, 273, 345, 452, 546, 720, 914, 1200				
Gear Box					
Leadscrew dia. and threads per inch	1 $\frac{1}{4}$ "-4 thd.	1 $\frac{1}{4}$ "-4 thd.	1 $\frac{1}{4}$ "-4 thd.	1 $\frac{1}{4}$ "-4 thd.	1 $\frac{1}{4}$ "-4 thd.
Range of threads per inch	1 $\frac{1}{2}$ to 92	1 $\frac{1}{2}$ to 92	1 $\frac{1}{2}$ to 92	1 $\frac{1}{2}$ to 92	1 $\frac{1}{2}$ to 92
Range of feeds per revolution	.0011"-.070"	.0011"-.070"	.0011"-.070"	.0011"-.070"	.0011"-.070"
Thread and feed changes	48	48	48	48	48
Threads cut	1 $\frac{1}{2}$, 1 $\frac{5}{8}$, 1 $\frac{3}{4}$, 2, 2 $\frac{1}{4}$, 2 $\frac{1}{2}$, 2 $\frac{3}{4}$, 2 $\frac{7}{8}$, 3, 3 $\frac{1}{4}$, 3 $\frac{1}{2}$, 4, 4 $\frac{1}{2}$, 5, 5 $\frac{1}{2}$, 5 $\frac{3}{4}$, 6, 6 $\frac{1}{2}$, 7, 8, 9, 10, 11, 11 $\frac{1}{2}$, 12, 13, 14, 16, 18, 20, 22, 23, 24, 26, 28, 32, 36, 40, 44, 46, 48, 52, 56, 64, 72, 80, 88, 92				
Tailstock					
Spindle diameter	2 $\frac{3}{8}$ "	2 $\frac{3}{8}$ "	2 $\frac{3}{8}$ "	2 $\frac{7}{8}$ "	2 $\frac{7}{8}$ "
Spindle travel	5 $\frac{1}{2}$ "	5 $\frac{1}{2}$ "	5 $\frac{1}{2}$ "	6"	6"
Center, Morse taper	No. 3	No. 4	No. 4	No. 4	No. 4
Carriage and Compound					
Carriage length	20"	20"	20"	22"	22"
Carriage bridge width	6"	6"	6"	7"	7"
Compound rest top slide travel	2 $\frac{1}{2}$ "	2 $\frac{1}{2}$ "	2 $\frac{1}{2}$ "	3"	3"
Lathe tool shank size for round tool post	1 $\frac{1}{2}$ "x1 $\frac{1}{8}$ "	5 $\frac{5}{8}$ "x1 $\frac{3}{8}$ "	5 $\frac{5}{8}$ "x1 $\frac{3}{8}$ "	3 $\frac{3}{4}$ "x1 $\frac{5}{8}$ "	3 $\frac{3}{4}$ "x1 $\frac{5}{8}$ "
Standard size tool bit	$\frac{5}{16}$ "	$\frac{3}{8}$ "	$\frac{3}{8}$ "	$\frac{7}{16}$ "	$\frac{7}{16}$ "
Bed width	12"	12"	12"	15"	15"
Main Drive Motor 1800 rpm, 220/440 volt, ball bearing with reversing starter, 110 volt push button start-stop-reverse control	5 hp	5 hp standard 7 $\frac{1}{2}$ hp optional		7 $\frac{1}{2}$ hp	7 $\frac{1}{2}$ hp
Net Weight , with average accessory equipment including all electrical equipment	3510 lbs.	3725 lbs.	4125 lbs.	4250 lbs.	4680 lbs.
Domestic shipping weight, as above	3915 lbs.	4165 lbs.	4610 lbs.	4690 lbs.	5160 lbs.

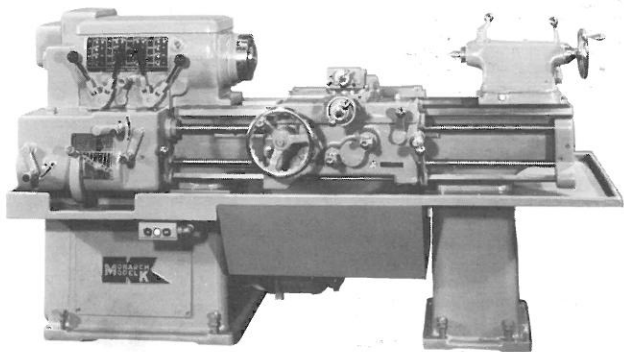

K-13

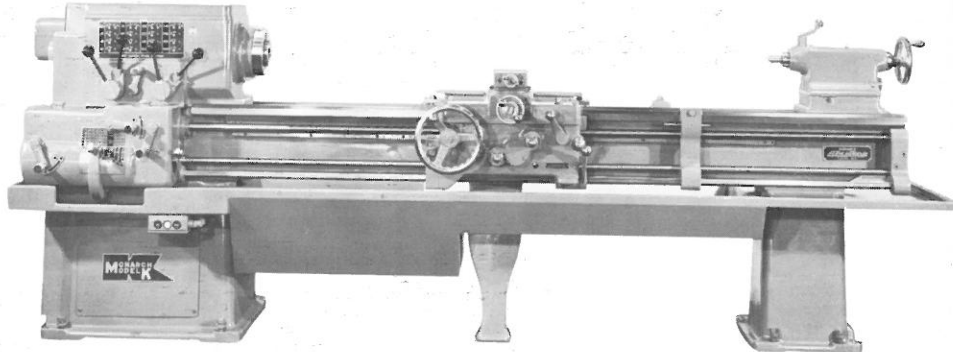

K-18



Ask about the Monarch deferred payment and tool lease plans.



For more than fifty years, Monarch craftsmen and engineers have built not only lathes but a reputation for the **best** lathes. We recognize that the future of our company depends upon our ability to maintain and further expand our capabilities. Here is why you can continue to look to Monarch for leadership in the development of machines of superior design, painstaking construction, more efficient, on-the-job productivity.

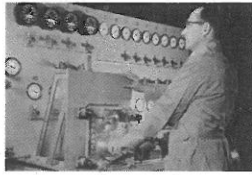

To meet the challenge of tomorrow's technology, Monarch mechanical, electrical and hydraulic engineers are continually developing new turning concepts for application to new and improved Monarch lathes.



Monarch metallurgical engineers are seeking methods to achieve even higher removal rates and shorter cycle times. Results of their research are available to all lathe users.



Monarch metallurgists and chemists are engaged in metallurgical analyses, hardness and stress tests and heat treating research. Their findings are reflected in Monarch's high standards of quality.



Monarch was first to apply numerical control to metal turning problems. Pioneers in tracer control, too. Monarch makes standard, tracer and numerically controlled lathes. As a result, we can evaluate your turning requirements objectively.

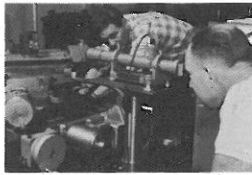

Monarch Super Precision lathes guarantee the \pm millionths of an inch tolerances demanded in such fields as missiles and instrumentation.



Superior workmanship. Skilled craftsmen. Modern methods and equipment. Experienced, on-the-spot management. These are the factors responsible for Monarch's continuing high standards and high quality.



Come to Sidney and **see** this synthesis of men, materials, methods and machines applied to routine or complex turning problems . . . many of them similar to your own.



MONARCH MACHINE TOOL COMPANY

Sidney, Ohio • Area Code 513, 492-4111